



Sports Series

Owner's Handbook

Assistance

Retailer Network

| | |
|----------------------|---|
| McLaren Auckland | 24 hours: +64 0508 MCLAREN |
| McLaren Bangkok | 24 hours: +66 813 594 300 |
| McLaren Fukuoka | 24 hours: +81 120 838 680 |
| McLaren Gold Coast | Australia Allianz Roadside Assist: 1800 626 768 |
| McLaren Hong Kong | 24 hours: +85 262 828 073 |
| McLaren Jakarta | 24 hours: +62 811 163 0122 BlackBerry® PIN: 24C64DC7 |
| McLaren Kaohsiung | 24 hours: +88 680 021 8208 |
| McLaren Kuala Lumpur | 24 hours: +60 193 396 888 |
| McLaren Melbourne | 24 hours: +61 283 382 188 Australia Allianz Roadside Assist: 1800 626 768 |
| McLaren Nagoya | 24 hours: +81 120 838 680 |
| McLaren Osaka | 24 hours: +81 120 838 680 |
| McLaren Seoul | 24 hours: +82 234 826 565 |
| McLaren Singapore | 24 hours: +65 64 304 888 |

| | |
|-------------------------|---|
| McLaren Sydney | 24 hours: +61 283 382 188 Australia Allianz Roadside Assist: 1800 626 768 |
| McLaren Taipei | 24 hours: +88 680 021 8208 |
| McLaren Tokyo | 24 hours: +81 120 838 680 |
| McLaren Client Services | +44 148 326 1500 UK business hours client.services@mclaren.com |

Australia only: If you have been unable to obtain assistance using the number(s) listed for towing/roadside assistance, or the dealer is unable to provide towing/roadside assistance, please call 1800 626 768.

For further information on contacting McLaren retailers, please refer to your Service and Warranty book.



Contents

1.1 Before You Drive

2.1 Driving Controls

3.1 Instruments

4.1 Comfort and Convenience

5.1 Maintaining Your McLaren

6.1 Vehicle Data and Glossary

Introduction

Introduction

Please read this information to familiarise yourself with your McLaren and its features before you drive. This provides the necessary information for you to get the optimum benefit and enjoyment from your McLaren.

This publication describes all options and features available for the McLaren Sports Series. Certain descriptions, including those for display and menu functions, may not apply to your vehicle due to model variant, country specifications, optional equipment or the fitment of McLaren approved accessories.

 **NOTE:** The images shown in this publication may not exactly reflect your unique vehicle.

The documents supplied with your McLaren are an integral part of the vehicle. Ensure that you pass them onto the new owner if you sell the vehicle.

The information is divided into specific sections, to assist in finding the particular information you require:

Before you drive

Details the settings you need to make in the cockpit to ensure you are fully prepared and have safe and easy access to all controls before driving.

Driving Controls

This section contains detailed information regarding the equipment and driving controls fitted to your McLaren and how to use those controls to best effect during a journey.

Instruments

This section contains information on the instrument cluster, including information of how to view and change vehicle settings.

Comfort and Convenience

Contains information on those systems and features which make the cockpit a pleasant environment in which to spend time.

Maintaining your McLaren

Information on maintaining your McLaren is here. Also included is advice on using your McLaren in winter weather and if you choose to drive your vehicle abroad, what to do if something should go wrong and how to

manage any possible problems which arise as a result. Information on fuses, lights and what to do if you experience a puncture.

Vehicle Data and Glossary

Refer to this section when you need information regarding the fluids and quantities that are required for the various systems on your McLaren, or when you need to know a specific piece of data relating to your McLaren or its performance.

The technical glossary contains a brief explanation of some of the more complex systems fitted to your McLaren. Your McLaren retailer will be able to assist should you need more information.

Index

The table of contents and the index will help you find information quickly, when you need it.

Introduction

Information about this document

McLaren is constantly updating its vehicles to meet and exceed the latest technologies. McLaren therefore reserves the right to introduce changes in design, equipment and technical features at any time.

© McLaren Automotive Limited.

This publication must not be reproduced, translated or reprinted, in whole or in part, without written permission from McLaren Automotive Limited.

The equipment fitted to your McLaren may vary from that shown depending on vehicle and market specification. Your McLaren may vary from the images shown depending on vehicle and market specification.

All information, illustrations and specifications in our applications are based on data available and are correct at the time of issue. The availability of options may vary from market to market due to local restrictions and regulations. Some illustrations in this applications may not necessarily reflect the specifications or options available in your local market and may show optional equipment. The specifications contained in these

applications are for information purposes only and McLaren Automotive reserves the right to change product specifications at any time without notice or incurring obligation. For full specification details and information on standard and optional equipment, please consult your McLaren retailer.

This vehicle may be covered by patents. See cars.mclaren.com/patents.

Printed in United Kingdom, 13QA335CP.

Electronic User Manual

If your vehicle is fitted with an electronic user manual, the Owner's Handbook and IRIS User Guide are available on the IRIS screen.

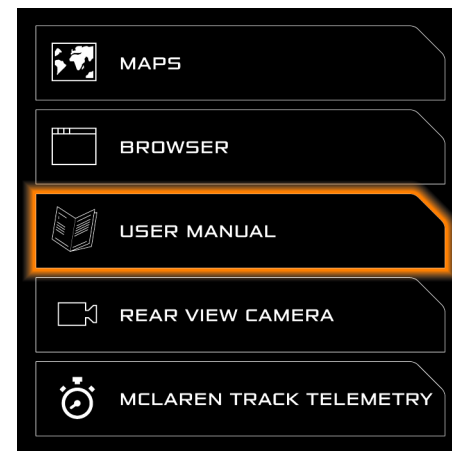

To access the manuals, navigate to the APPS screen and select USER MANUAL. This will launch the user manual application.

Introduction

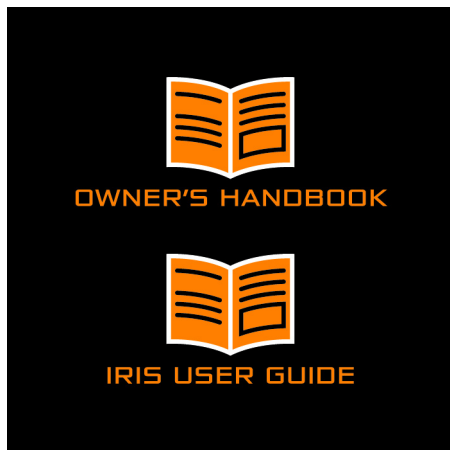

Select the OWNER'S HANDBOOK or IRIS USER GUIDE to access the information.

CONTENTS

INTRODUCTION
BEFORE YOU DRIVE
DRIVING CONTROLS
INSTRUMENTS
COMFORT AND CONVENIENCE
MAINTAINING YOUR MCLAREN
VEHICLE DATA AND GLOSSARY
INDEX

Select the chapter required, this will take you to the chapter contents page.

i NOTE: Selecting the INDEX from the main contents page will navigate you to an alphabetical index of topics covered in the Owner's Handbook. The INDEX is not available for the IRIS User Guide.

DRIVING CONTROLS

STARTING AND DRIVING
SEAMLESS SHIFT GEARBOX
HANDLING AND POWERTRAIN CONTROLS
DRIVING SAFETY SYSTEMS
CRUISE CONTROL
ACTIVE SPEED LIMITER (ASL)
RUNNING IN
REFUELLING
WINTER DRIVING

Select the section required from the chapter contents to access the required information.

When the section is displayed, the screen can be scrolled by touching the screen and dragging a finger up or down as required. Hotspot links are identified by orange underlined text. Selecting a hotspot link will navigate you to the information identified in the text.

Introduction



The Library icon appears at the top of the main contents page. Selecting the library button will return you to the library where all available owner information can be accessed.



The Home icon appears at the top and the bottom of each page. Selecting the home button will return you to the main contents page.



The icons at the bottom of the screen (end of the section) can be used to navigate to the previous or next section as required.

Symbols

You will find the following symbols in this Owner's Handbook. These symbols are intended to give you an instant visual message on what type of information is being displayed.

| | |
|---------------------|--|
| Warnings | |
| | A warning draws your attention to activities that could cause injury or death. |
| Notes | |
| | Notes draw your attention to activities that contain possible risks to your McLaren, provide advice that you may find useful, or give additional information regarding a particular subject. |
| Environmental notes | |
| | Environmental notes give you tips on minimising the impact of you and your vehicle on the environment. |

Operating safety



WARNING: The electronic systems fitted to your McLaren interact with each other. Tampering with these systems could cause malfunctions in other interconnected systems. Such faults could seriously endanger the operational safety of your McLaren and your own safety.

Additional work or modifications made to the vehicle, which have been carried out incorrectly can also affect its operating safety.

Introduction

Vehicle use

Observe the following when using your McLaren:

- the safety notes throughout this information
- road traffic laws and regulations



WARNING: There are various warning labels attached to your McLaren. These are intended to make you and others aware of various risks. Do not remove any warning labels from the vehicle.

If you remove these warning labels, you or others may not then be aware of dangers, which may result in an injury.

Ground clearance



WARNING: Damage to the underside of the vehicle may occur when approaching steep inclines or declines.

Drive with care when:

- approaching kerbs
- approaching steep inclines
- departing steep declines
- driving on rough roads
- driving in areas where traffic calming measures have been deployed
- driving in any other environment where sudden change of road surface height or elevation are encountered such as car parks

See Vehicle dimensions, page 6.8.

Track driving

To achieve optimum performance and reliability it is important to ensure the following preconditions are met before attempting to drive your vehicle on a track:

- engine oil is at normal operating temperature
- engine coolant is at normal operating temperature
- tyres should not exceed the safe operating temperatures



NOTE: Before you use your vehicle on the track, consult your McLaren retailer. McLaren recommend that your vehicle is inspected before and after track use.



NOTE: Always drive within your limits and the limits of the vehicle.

Cooling down

We recommend you take time to cool the vehicle during track driving due to the high temperatures that may be generated by the brakes and transmission which could affect performance. Time should be taken to drive the vehicle at a slower speed without using

Introduction

hard braking or carrying out excessive gear changes, this uses the airflow to cool the vehicle.

We recommend that time is allowed for your vehicle to return to normal operating temperatures before leaving the track.

i **NOTE:** When stopping the vehicle directly after performance driving we recommend that the ignition is not immediately switched off or the parking brake is applied. We recommend that the engine is left to idle prior to the ignition being switched off.

i **NOTE:** Please refer to your Service and Warranty Guide for track and competition use implications.

Stored Data

There are a number of components in your vehicle which collect data and store it temporarily or permanently. This technical data provides information relating to areas such as the condition of the vehicle, any events which have taken place and any malfunctions your vehicle may be experiencing or has experienced in the past.

These include, for example:

- operating conditions of system components, e.g. fluid levels
- the vehicle's status messages and those of its individual components, e.g. 'Windscreen washer fluid low'
- malfunctions and defects in important system components, e.g. 'Light switch fault'
- vehicle reactions and operating conditions in special driving situations, e.g. air bag deployment
- ambient conditions, e.g. outside temperature

This data is of an exclusively technical nature and can be used to:

- assist in recognising and rectifying faults and defects
- analyse vehicle functions, e.g. after an accident
- optimise vehicle functions

The data cannot be used to trace the vehicle's movements.

When your vehicle is serviced, technical information can be read from the vehicle including:

- repair service history
- warranty events
- quality assurance

This information can be read by employees of the service network (including manufacturers) using special diagnostic testers. More detailed information can be obtained from it, if required.

After a fault has been rectified, the information is deleted from the fault memory or is continually overwritten.

When operating the vehicle, situations may occur where technical data, in connection with other information, could be traced to a person.

Examples include:

Introduction

- accident reports
- damage to the vehicle
- witness statements

McLaren will not access your behaviour related information about a crash event or share it with others except:

- with the consent of you or, if the vehicle is leased, of the lessee
- in response to an official request of police or similar government office
- as part of the manufacturer's defence in case of legal proceedings
- as required by law

In addition, McLaren may use the collected or received diagnostic data:

- for McLaren's research needs
- to make it available for research needs where appropriate confidentiality is maintained and need is shown
- to share summary data which is not tied to a specific vehicle with other organisations for research purposes

Before You Drive

| | | | |
|--|-------------|---|-------------|
| Opening and Closing | 1.4 | Manual seats | 1.31 |
| General | 1.4 | Racing seats | 1.32 |
| Opening a door | 1.6 | Electric seats | 1.33 |
| Locking a door | 1.6 | Steering Wheel and Steering Column | 1.38 |
| Mislock | 1.8 | Manual steering wheel adjustment | 1.38 |
| Individual settings | 1.9 | Electric steering wheel adjustment | 1.38 |
| Locking and unlocking from inside - Coupe | 1.9 | Horn | 1.40 |
| Locking and unlocking from inside - GT | 1.9 | Occupant Safety | 1.41 |
| Locking and unlocking from inside - Spider | 1.10 | Seat belts | 1.41 |
| Opening a door from inside | 1.10 | Supplementary Restraint System | 1.43 |
| Closing a door | 1.11 | Child passengers | 1.47 |
| Automatic locking | 1.11 | Mirrors | 1.50 |
| Service Cover - Coupe and Spider | 1.12 | Safety | 1.50 |
| Service Cover - GT | 1.13 | Interior mirror | 1.50 |
| Front luggage compartment | 1.15 | Exterior mirrors | 1.50 |
| Rear luggage compartment - GT | 1.17 | Lighting | 1.52 |
| Retractable Roof - Spider models | 1.18 | Exterior lighting | 1.52 |
| Backlight - Spider models | 1.21 | Light switch | 1.54 |
| Tonneau Cover - Spider models | 1.23 | Main beam headlamps | 1.55 |
| Stowing Luggage | 1.25 | Daytime running lamps (except Japan) | 1.56 |
| Stowage Luggage - Spider models | 1.25 | Rear fog lamp | 1.56 |
| Anti-Theft System | 1.28 | Direction indicators | 1.57 |
| Alarm system | 1.28 | Hazard warning lamps | 1.57 |
| Immobiliser | 1.28 | Parking lights | 1.58 |
| Tow-away protection | 1.29 | Washers and Wipers | 1.59 |
| Interior motion sensor | 1.30 | Windscreen wipers | 1.59 |
| Seats | 1.31 | | |
| Safety | 1.31 | | |

Nose Lift 1.61
Nose Lift Operation..... 1.61

Before You Drive

Opening and Closing

General

The vehicle can be unlocked or locked either by using the keyless entry feature, or by pressing the appropriate button on the key fob.

The keyless entry feature requires the key to be within 1.2 metres (3 feet 11 inches) of the sensors.

For your convenience, provided that the engine is not running, the vehicle can be locked irrespective of the electrical status, see Vehicle electrical status, page 2.2.

Keyless entry

Keyless entry allows the driver to unlock and disarm the vehicle by simply opening the door when the key fob is within 1.2 metres (3 feet 11 inches) of the sensors. The key fob needs only to be on the driver's person or in a non-metallic container such as a bag. It does not need to be exposed or handled.

Four sensors detect where the key fob is around the vehicle.

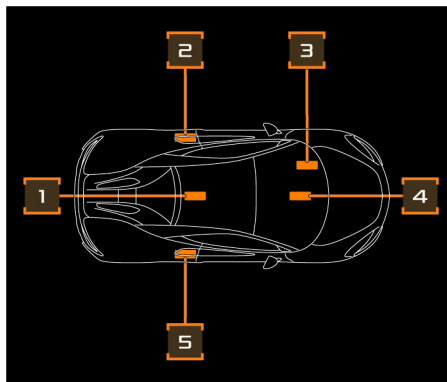

Right-hand drive models

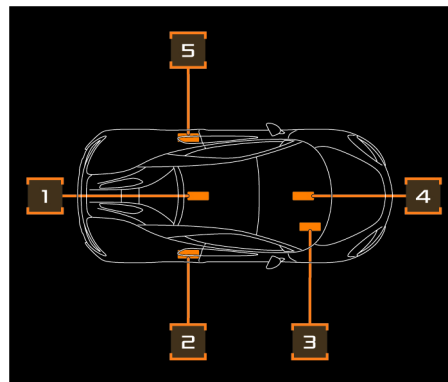

Left-hand drive models

1. Rear in vehicle sensor
2. Passenger's door sensor
3. Passenger's footwell sensor
4. Front in vehicle sensor
5. Driver's door sensor

Before You Drive

Opening and Closing

Key fob entry

Your McLaren includes two remote control key fobs. The key fob allows you to remotely lock and unlock the vehicle.

i NOTE: To prevent theft, only use the key fob in the immediate vicinity of the vehicle.

The key fob locks and unlocks the following:

- the doors (including fuel filler flap)
- the luggage compartment
- the centre console stowage compartment
- the glove box

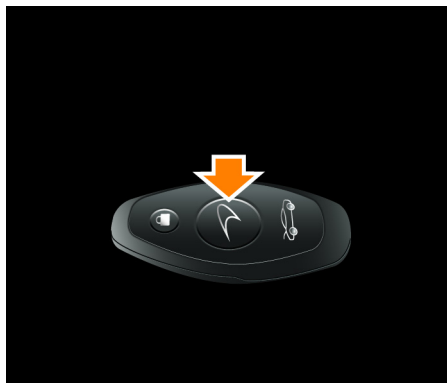

To unlock the vehicle, using the key fob, press the unlock button. The front, rear and side direction indicators (market specific) flash twice and the anti-theft alarm system will be deactivated.

The unlock button operation changes depending whether the DRIVER or BOTH is selected in the vehicle settings, see Door Unlock, page 3.23.

! **WARNING: The key fob allows the engine to be started and is also used to activate other features on the vehicle.**

Take the key fob with you, every time you leave the vehicle.

i NOTE: Do not expose the key fob to high levels of electromagnetic radiation. Doing so may cause it to function incorrectly. For example close proximity to laptops, tablets, personal media players, or mobile phones.



| Unlock Button | Outcome |
|---------------|--|
| Single Press | If BOTH is selected, a single press of the button unlocks both doors. If DRIVER is selected, a single press of the button unlocks the driver's door. A second press (after a pause) unlocks the passenger's door. |
| Double Press | If BOTH is selected, a double press of the button unlocks both doors and unlatches the driver's door. If DRIVER is selected, a double press of the button will unlock and unlatch the driver's door only. |

Before You Drive

Opening and Closing

Stowing the key fob

For security, it is recommended that the key fob stays on your person when you are in the vehicle. If, however, you wish to stow the key fob within the vehicle, ensure that it is not left in plain view.

-  NOTE: If the message 'key not found within vehicle' appears on the instrument cluster, reposition key fob until it is detected.
-  NOTE: Do not stow the key fob in the centre console stowage compartment, in the cup holders, in the stowage nets between the seats, in the door stowage compartments, or on the shelf immediately behind the seats as the system may not detect its presence and the engine will not start.

Discharged battery

If you are unfortunate enough to experience a fully discharged battery, the vehicle can still be opened using the mechanical key, see Unlocking - discharged battery, page 5.25.

Opening a door

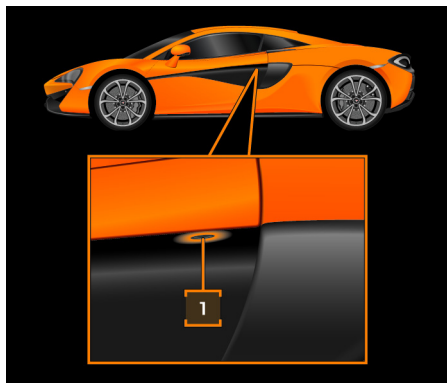

1. Press the button (1) firmly to unlock and unlatch the door.

-  NOTE: Ensure the key is within a 1.2 metres (3 feet 11 inches) range of the door sensors when using the keyless entry feature.

 **WARNING: Always stand to the rear of the door before opening it, as the opening action may cause injury. The speed that the door opens will be affected by ambient temperature.**

-  NOTE: Because the door opens outwards and then upwards, ensure sufficient side and overhead clearance before opening a door, see Vehicle dimensions, page 6.8.

2. If keyless entry is used, the front, rear and side direction indicators (market specific) will flash twice, and the anti-theft alarm system will be deactivated.
3. The door latch will then release, allowing the door to be partially raised before it automatically swings outwards and upwards. The mirrors will unfold if folded.

-  NOTE: When the door is opened, the window will lower slightly. It will raise to the closed position once the door is shut. If the window does not lower, for example, due to a discharged battery or freezing temperatures, take care when opening and closing the door. Do not force the door during opening or closing, as this could lead to the door seals or window becoming damaged.

-  NOTE: A sustained long press and hold on the unlock button will automatically lower the windows. The

Before You Drive

Opening and Closing

windows will continue to lower until the unlock button is released or the windows are fully lowered.

- i** NOTE: If the vehicle is unlocked using the key fob but the doors or luggage compartment are not opened, the vehicle will relock after 30 seconds.

Locking a door

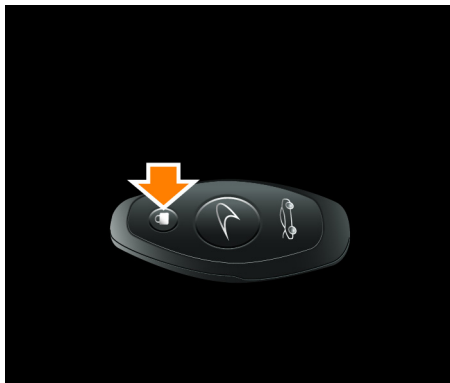

1. Close the door. See Closing a door, page 1.11.

2. To lock the vehicle using the key fob, press the lock button. The front, rear and side direction indicators (market specific) flash in a rapid, circular sequence around the vehicle. The anti-theft alarm system is activated.

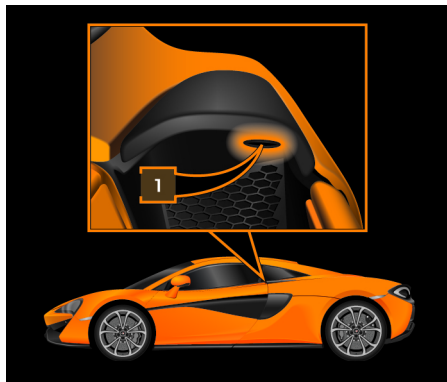

3. If using the keyless entry feature, press the touch sensitive switch (1) below the top surround within the side pod.
- i** NOTE: Ensure the key is within a 1.2 metre (3 feet 11 inches) range of the door sensors when using the keyless entry feature.

- i** NOTE: The lock switch will recognise a single press.
- i** NOTE: The lock switch is touch activated. There is no mechanical travel or audible feedback when pressed.
- i** NOTE: A sustained long press and hold on the lock switch will automatically raise the window. The window will continue to raise until the lock switch is released or the window is fully closed.
- 4. The direction indicators flash to indicate that the anti-theft alarm system is activated.
- i** NOTE: When the door is opened the door glass will lower slightly to avoid contact with other parts of the vehicle. When the door is closed the glass will raise to the closed position automatically. If for any reason the door glass does not raise it is likely that the system has sensed a “trap” event. This can be caused by debris in the glass channel or misalignment of the glass. Ensure there are no obvious signs of debris in the glass channel, and hold the lock button. The glass will

Before You Drive

Opening and Closing

raise providing the door is correctly closed and there are no obstructions preventing it raising. If the glass does not close, or the glass repeatedly fails to automatically raise, contact your McLaren retailer.

Mislock

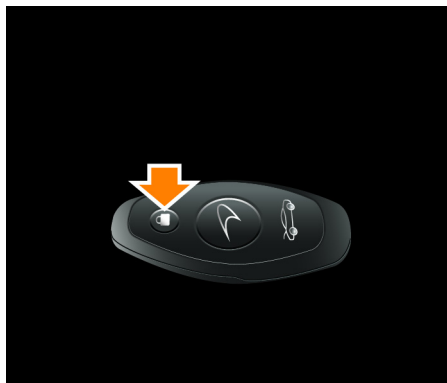

If either the doors, the luggage compartment lid or the service cover are left open, or the key fob is still inside the vehicle, an audible 'mislock' signal will sound when an attempt to lock the vehicle is made using the key fob. On Spider models, the 'mislock' signal will also sound when an attempt is made to lock the vehicle if the tonneau cover is not fully closed or if the roof is not fully opened or fully closed.

i NOTE: If the doors are open or the key fob is still inside the vehicle, a momentary sounding of the alarm

horn will alert you. If the luggage compartment lid or service cover is open, a long tone will alert you. The long tone will also indicate that the tonneau cover is open or the roof is not fully open or fully closed on Spider models.

Check that the doors, the luggage compartment lid, the service cover and the tonneau cover (Spider only) are all closed and that the roof is fully open or fully closed (Spider only), then relock the vehicle.

i NOTE: The vehicle can be locked/alarmed with the luggage compartment open. A long tone sounds to alert you to this condition, and differs to the short tone sounded for door open/key in vehicle mislock. The luggage compartment will become alarmed as soon as the luggage compartment lid is closed. This will allow you to connect a McLaren supplied battery charger to the charging point in the luggage compartment whilst leaving the rest of the vehicle locked.

Before You Drive

Opening and Closing

Individual settings

If you frequently travel without passengers, you can change the locking system so that only the driver's door is unlocked, see Auto Door Lock, page 3.23.

If only the driver's door has been configured to unlock, the passenger's door can only be unlocked by either pulling the passenger's door internal handle, pressing the unlock button on the key fob again or by unlocking the vehicle from the central locking button on the centre console.

Locking and unlocking from inside - Coupe



1. Press the central locking button to lock the vehicle, the light in the button will illuminate to indicate that the vehicle is locked.
2. Press the central locking button again to unlock the vehicle and the light in the button will be extinguished.

Locking and unlocking from inside - GT

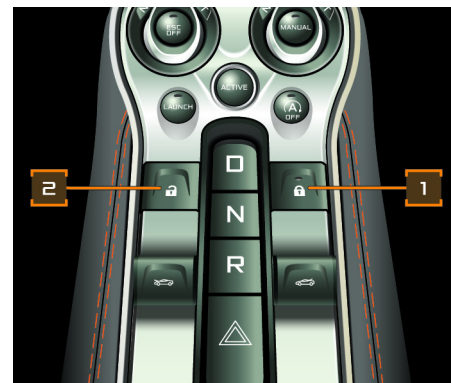

1. Press the central locking lock button to lock the vehicle, the light in the button will illuminate to indicate that the vehicle is locked.
2. Press the central locking unlock button to unlock the vehicle and the light in the lock button will be extinguished.

Before You Drive

Opening and Closing

Locking and unlocking from inside - Spider



1. Press the central locking button to lock the vehicle, the light in the button will illuminate to indicate that the vehicle is locked.
2. Press the central locking button again to unlock the vehicle and the light in the button will be extinguished.

Opening a door from inside

A door can be opened from inside the vehicle at any time, even if it has been locked. Open the doors only if the vehicle is stationary and road and traffic conditions permit.

- i** NOTE: Because the door opens outwards and then upwards, ensure sufficient side and overhead clearance before opening a door.



1. Pull door handle upwards, in direction of arrow, and push the door outwards until the opening mechanism takes over. The door will then swing outwards and upwards automatically.

- i** NOTE: When the door is opened, the window will lower slightly. It will raise to the closed position once the door is shut. If the window does not lower, take care when opening and closing the door. Do not force the door during opening or closing, as this could lead to the door seals or window becoming damaged.

Before You Drive

Opening and Closing

Closing a door

1. Push/pull the door downwards and ensure that it latches securely.

WARNING: Keep hands and other objects clear of the door edge when closing. This is particularly important for vehicles fitted with soft close latches as the door will automatically continue to the fully closed position when the first catch has engaged. There is no anti-trap feature preventing the door closing if an item or body part is trapped between the door and the door aperture, serious injury and vehicle damage may occur.

If the window does not close, this may be due to an anti-trap event. Try one of the following:

- reopen and close door
- lock vehicle using the lock switch on the bodyside

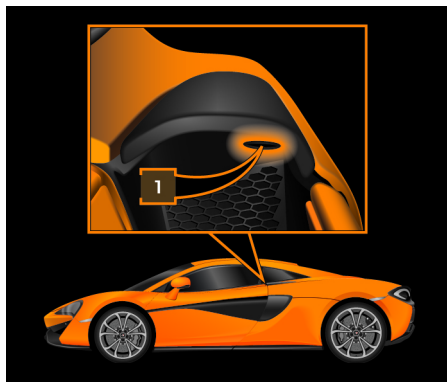

In the event of continuous anti-trap events, press the lock switch (1) for a few seconds. The window will continue to raise until you remove your finger from the lock switch. Only attempt this if the above methods do not resolve the problem.

NOTE: Do not force the door closed, the door seals or window could be damaged.

Automatic locking

The doors and the luggage compartment lock automatically after the vehicle has driven away.

NOTE: The doors unlock automatically in an accident if the force of the impact exceeds a predetermined level.

The automatic locking function is selectable in the vehicle settings section of the instrument cluster, see Auto Door Lock, page 3.23. If automatic locking is ON, the interior central locking button will illuminate once the vehicle locks on drive away.

Before You Drive

Opening and Closing

Service Cover - Coupe and Spider

Opening

 **WARNING:** The exhaust tail pipes can be very hot and there is a risk of severe burns. Only open the service cover from the side of the vehicle.

 **WARNING:** There is a risk of injury if the service cover is open, even when the engine is not running.

Engine components become very hot and there is a risk of severe burns.

The engine ignition system carries a high voltage. Never touch ignition system components; ignition coils, ignition wiring (spark plug connections).

 **WARNING:** If the engine is stopped due to the Eco Start-Stop System, the engine may restart without warning.



1. Press the release button on the rear edge of the driver's door, the service cover will open slightly.



Coupe

Before You Drive

Opening and Closing

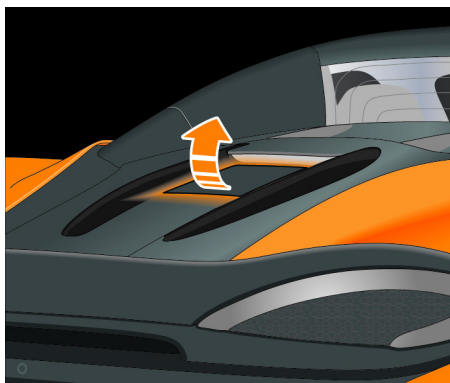

Spider

2. From the side of the vehicle, lift the service cover. The hinge will support the cover in the raised position.
See Topping up the engine oil, page 5.3.
See Topping up the coolant, page 5.6.

Closing

 **WARNING:** The exhaust tail pipes can be very hot and there is a risk of severe burns. Only close the service cover from the side of the vehicle.

Press the service cover down squarely from the side of the vehicle and ensure that the cover latches securely.

Service Cover - GT

Opening

 **WARNING:** The exhaust tail pipes can be very hot and there is a risk of severe burns. Only open the service cover from the side of the vehicle.

 **WARNING:** There is a risk of injury if the service cover is open, even when the engine is not running.

Engine components become very hot and there is a risk of severe burns.

The engine ignition system carries a high voltage. Never touch ignition system components; ignition coils, ignition wiring (spark plug connections).

 **WARNING:** If the engine is stopped due to the Eco Start-Stop System, the engine may restart without warning.

1. Open the rear luggage compartment.
See Rear luggage compartment - GT, page 1.17.

Before You Drive Opening and Closing

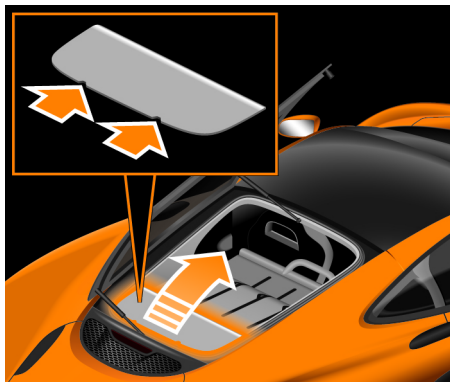

2. Using the indents on the rear edge, release the luggage compartment floor from the 2 x press-studs and place inside the luggage compartment, clear of the fill points.

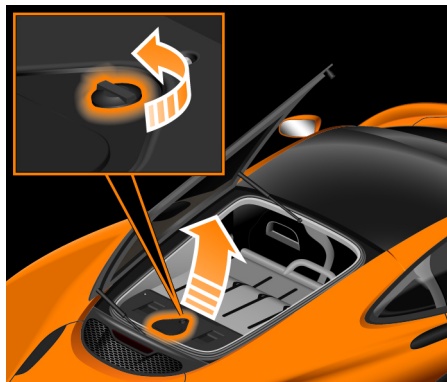

3. Rotate the release catch quarter of a turn anti-clockwise, lift the service cover from the front and remove. See Topping up the engine oil, page 5.3. See Topping up the coolant, page 5.6.

Closing

 **WARNING:** The exhaust tail pipes can be very hot and there is a risk of severe burns. Only close the service cover from the side of the vehicle.

1. Replace the service cover, fitting the rear edge first, then rotate the catch quarter of turn clockwise to secure in place.
2. Replace the luggage compartment floor, securing in place with the press-studs.

Before You Drive

Opening and Closing

Front luggage compartment

i NOTE: The luggage compartment will only open if the vehicle is stationary and neutral is selected.

A message will display on the instrument cluster if the luggage compartment is open when pulling away.

i NOTE: When the luggage compartment is unlatched or open, gear selection will be inhibited. Press and hold D or R for 5 seconds to override this and select a gear if there is a need to manoeuvre the vehicle.

! **WARNING: Only manoeuvre the vehicle at low speed if the luggage compartment is open or unlatched as the drivers' view may become obscured.**

Opening



1. Press the luggage release button on the key fob, the luggage compartment will fully unlock and open slightly.



Coupe

2. Alternatively, press the centre console button to fully unlock and slightly open the luggage compartment.

Before You Drive Opening and Closing



GT

3. Lift the front of the luggage compartment lid, the gas struts will support it in the fully open position.



Spider

Closing

⚠ WARNING: Ensure that no one can be trapped as you close the luggage compartment.

1. Pull the luggage compartment lid down firmly and ensure that it is latched securely.

i NOTE: Do not leave the key fob in the luggage compartment, as the vehicle may lock, and you may be locked out of the vehicle.

i NOTE: If the vehicle had previously been locked, it will still be locked and the direction indicators will flash as the lid closes.

2. The luggage compartment will become alarmed as soon as the luggage compartment lid is closed.

i NOTE: The vehicle can be locked/alarmed with the luggage compartment open. This will allow you to charge the battery while leaving the rest of the vehicle locked. A long tone sounds to alert you to this.

Before You Drive

Opening and Closing

Rear luggage compartment - GT

WARNING: Do not exceed rear luggage area maximum load, see Vehicle weights, page 6.9.

WARNING: Do not carry unsecured objects inside the vehicle. Occupants could be injured by objects being thrown around during sharp braking, a sudden change of direction or an accident.

NOTE: The luggage compartment will only open if the vehicle is stationary and neutral is selected.

A message will display on the instrument cluster if the luggage compartment is open when pulling away.

NOTE: When the luggage compartment is unlatched or open, gear selection will be inhibited. Press and hold D or R for 5 seconds to override this and select a gear if there is a need to manoeuvre the vehicle.

WARNING: Only manoeuvre the vehicle at low speed if the luggage compartment is open or unlatched as the drivers' view may become obscured.

Opening



1. Press the luggage release button on the key fob, the luggage compartment will fully unlock and open slightly.



2. Alternatively, press the centre console button to fully unlock and slightly open the luggage compartment.

Before You Drive

Opening and Closing



3. Lift the passenger's side of the luggage compartment lid, the gas struts will support it in the fully open position.

Closing

! **WARNING:** Ensure that no one can be trapped as you close the luggage compartment.

1. Pull the luggage compartment lid down firmly and ensure that it is latched securely.

i **NOTE:** Do not leave the key fob in the luggage compartment, as the vehicle may lock, and you may be locked out of the vehicle.

i **NOTE:** If the vehicle had previously been locked, it will still be locked and the direction indicators will flash as the lid closes.

2. The luggage compartment will become alarmed as soon as the luggage compartment lid is closed.

Retractable Roof - Spider models

The retractable roof comprises of two lightweight panels which, when operated, fold swiftly beneath the tonneau panel located behind the cockpit.

The roof is operated using the switch on the centre console.

The roof can be operated at speeds up to 25 mph (40 kph).

! **WARNING:** Do not place any objects between the moving parts of the roof. Make sure any occupants or bystanders are clear of the roof during operation. Operation of the roof may cause personal injury or damage to components.

! **WARNING:** Do not operate the roof if the stowage bags are fitted and in use in the tonneau area. The roof system and/or the backlight glass could be damaged.

! **WARNING:** To avoid damaging the operating mechanism and the vehicle interior, carefully remove surface water, ice or snow before operating the roof.

Before You Drive

Opening and Closing

The roof must only be operated if the stowage bags are not in use and stored securely in the stowage mounts.



i NOTE: Do not sit, stand or place any load on the backlight interior trim panel.

If you experience any problems with the roof, contact your Authorised McLaren Retailer immediately.

i NOTE: If the vehicle is stopped with the roof open, it is possible to close the roof before the vehicle goes to sleep to leave it secure.

Roof Operating Temperature

| | |
|---------------------------------------|--------------|
| Minimum ambient operating temperature | -10°C (14°F) |
|---------------------------------------|--------------|

i NOTE: Roof operation is inhibited when operated below the minimum ambient operating temperature.

Opening the roof

1. The vehicle must be awake with key present.
- i** NOTE: Operation of the roof will be halted whilst the engine is cranking.



2. Press and hold the switch to operate the roof. If you release the switch, the roof will stop until you press the switch again.

i NOTE: If the tonneau cover has been opened at any time while the roof is closed, the message 'Confirm Tonneau Empty' will be displayed on the left-hand instrument cluster.

Before You Drive

Opening and Closing

3. Check the tonneau area is empty and the stowage bags are correctly stowed. Press OK on the menu stalk, once you have confirmed this.

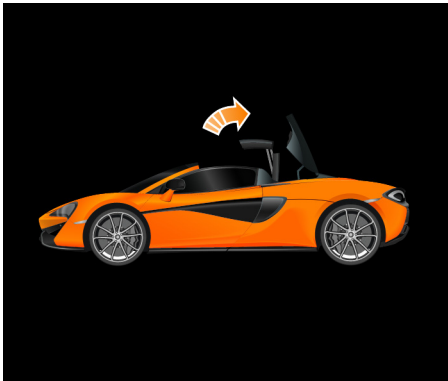

4. Press and hold the switch until the roof is fully open (stowed).

i NOTE: When the roof starts to move, the tonneau cover will open and the backlight glass will drop slightly. The message 'Roof Operation In Progress' will appear on the left-hand instrument cluster.

5. Once the roof is fully open (stowed), the tonneau cover will close and the backlight glass will return to an aero

position to reduce wind buffeting in the cockpit. The message 'Roof Open' will appear on the left-hand instrument cluster. An audible tone will confirm that the roof cycle is complete.

6. If the switch is held in the down position after the operation has completed, the windows and backlight will open fully.
7. If the vehicle speed rises above 25 mph (40 kph) while the roof is being operated, roof operation is paused. The message 'Reduce Vehicle Speed, Release and Re-press Button For Roof Operation' will appear on the left-hand instrument cluster.
8. Reduce the vehicle speed to below 25 mph (40 kph) and release the switch. The message 'Continue Roof Cycle' will appear on the left-hand instrument cluster. Press the switch again to continue desired roof cycle.

i NOTE: If the roof is not fully opened or closed, within 7 minutes the system will lower the roof to the nearest rest position. If this happens the roof will

not be securely latched and the roof must be fully opened/closed to make it secure before driving the vehicle.

Closing the roof

1. The vehicle must be awake with key present.
- i** NOTE: Operation of the roof will be halted while the engine is cranking.



2. Pull and hold the switch until the roof is in the fully raised (closed) position.
3. If you release the switch, the roof will stop until you press the switch again.

Before You Drive

Opening and Closing

- If the vehicle speed rises above 25 mph (40 kph) while the roof is being operated, roof operation is paused. The message 'Reduce Vehicle Speed, Release and Re-press Button For Roof Operation' will appear on the left-hand instrument cluster.
 - Reduce the vehicle speed to below 25 mph (40 kph) and release the switch. The message 'Continue Roof Cycle' will appear on the left-hand instrument cluster.
 - Pull the switch to continue closing until the roof and tonneau are fully closed and latched. The window and backlight glass will raise to the fully closed position. An audible tone will confirm that the roof cycle is complete.
 - Continuing to hold the switch after the roof cycle is complete will lower the window and backlight glass.
- i** NOTE: If the roof is not fully opened or closed, within 7 minutes the system will lower the roof to the nearest rest position. If this happens the roof will not be securely latched and the roof must be fully opened/closed to make it secure before driving the vehicle.

Backlight - Spider models

! **WARNING:** If the tonneau area is being used to stow luggage, please ensure that the stowage bags provided with the vehicle are used. If not, operation of the backlight could lead to damage to the backlight glass.

Lower the backlight, with the roof open, to obtain additional air flow around the cockpit. Raise the backlight to an aero position to reduce wind buffeting in the cockpit.

i NOTE: It is only possible to operate the backlight if the vehicle is awake with the key present.

The backlight switch is located on the centre console.

i NOTE: If you experience any problems with the backlight, contact your Authorised McLaren Retailer immediately.

Opening

- The vehicle must be awake with the key present.



- Press and hold the switch to lower the backlight. If you release the switch, the backlight will stop until you press the switch again.
- i** NOTE: If the tonneau cover has been opened while the roof is closed, the message 'Confirm Tonneau Empty' will be displayed on the left-hand instrument cluster.
- Check the tonneau area is empty and the stowage bags are correctly stowed. Press OK on the menu stalk, once you have confirmed this.

Before You Drive Opening and Closing

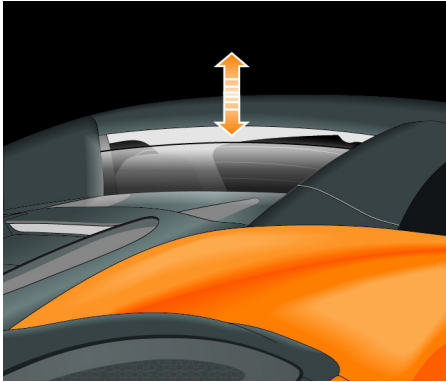

4. Press and hold the backlight switch to lower the backlight to the desired position.

i NOTE: Do not fully open the backlight when it is raining or snowing, as water could enter the cabin area and affect electrical components.



2. Pull and hold the backlight switch to raise the backlight until the backlight is in the desired position.

i NOTE: If the vehicle is stopped with the backlight open, you are able to close the backlight before the vehicle goes to sleep to leave it secure.

Closing

1. The vehicle must be awake with the key present.

Before You Drive

Opening and Closing

Tonneau Cover - Spider models

The tonneau cover is the panel behind the cockpit. The tonneau cover can be opened and closed and allows access to the area below.

The retractable roof is stowed in the area underneath the tonneau cover when the roof has been lowered. The tonneau cover is then closed.

Opening

1. The vehicle must be awake with key present.

WARNING: Do not place any objects between the moving parts of the tonneau. Make sure any occupants or bystanders are clear of the tonneau during operation. Operation of the tonneau may cause personal injury or damage to components.

i NOTE: Do not operate the tonneau cover whilst loading/unloading of the tonneau area is taking place. The vehicle will remain awake for a maximum of fifteen minutes while the tonneau is open.

i NOTE: Access to the tonneau storage area can only be made using the tonneau open/close buttons on the driver's door switch panel.

i NOTE: The key must be within range of the driver's door to enable tonneau control.



2. Press and hold the button on the rear edge of the driver's door until the tonneau cover is fully open.

i NOTE: The tonneau cover cannot be opened if the roof is open.

3. Check the tonneau area is empty and the stowage bags are correctly stowed. Press OK on the menu stalk, once you have confirmed this.

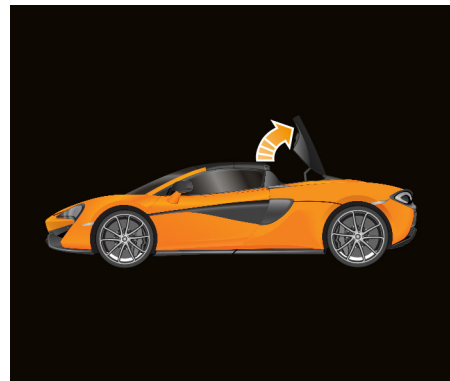

4. If the vehicle is driven whilst the tonneau cover is open, the message 'Tonneau Cover Open' will appear on the left-hand display, accompanied by an audible alert.

i NOTE: Only stow items in the tonneau area in the storage bags provided with your McLaren. See Stowage Luggage - Spider models, page 1.25.

Before You Drive

Opening and Closing

Closing



WARNING: Ensure that no one can be trapped as you close the tonneau cover.



1. Press and hold the button on the rear edge of the driver's door until the tonneau cover is fully closed.



NOTE: The tonneau cover can be closed for up to 15 minutes once it has been opened whilst the ignition is off. If this time has elapsed, switch the ignition on again to close the tonneau cover.



NOTE: The message 'Tonneau Operation In Progress' will appear on the left-hand display.



NOTE: The tonneau area will be alarmed when the vehicle is locked.



NOTE: Do not overfill the stowage bags. This could cause a tonneau cover fault, contact your Authorised McLaren Retailer immediately.

Before You Drive

Stowing Luggage

Stowage Luggage - Spider models

When the roof is raised, the area underneath the tonneau cover can be used for storing small items. Your McLaren is supplied with two stowage bags for this purpose.

⚠ WARNING: Do not place loose items in the tonneau area. This could lead to damage to the roof system and/or the backlight glass.

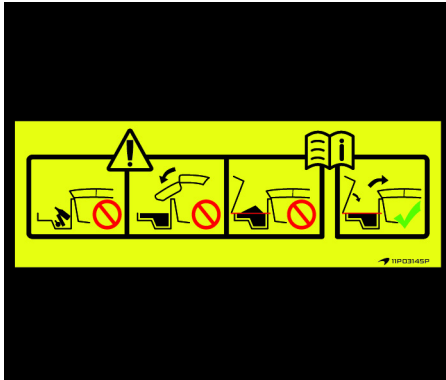

The stowage bags can be filled while in the tonneau area or out of the vehicle.

- i** NOTE: Only use the stowage bags provided. No other type of luggage bag can be used. The warning label on the interior of the tonneau cover confirms this.
- i** NOTE: Ensure the contents do not exceed the recommended fill level identified by the red line on the rear of the bulkhead area. The warning label on the bulkhead confirms this.
- i** NOTE: Do not overfill the stowage bags. The weight of each stowage bag and contents should not exceed 15 kg (33 lbs).
- i** NOTE: Do not fill the stowage bags with any of the following:
 - hazardous and/or volatile compounds or liquids
 - heavy and/or sharp objects
 - foods and/or liquids affected by heat
 - fragile items or items which are easily breakable

Before You Drive

Stowing Luggage

Installing stowage bags

1. Open the tonneau cover. Tonneau Cover - Spider models, page 1.23

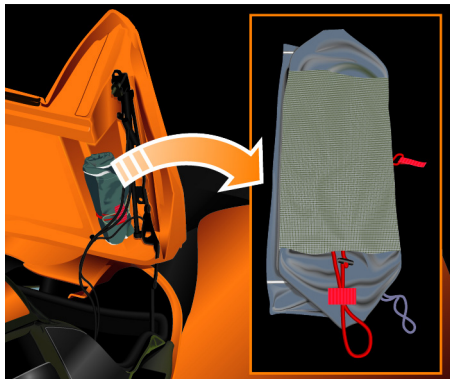

2. Remove the stowage bags from the mounts inside the tonneau cover.
3. Release the toggle and unroll the stowage bags.
4. Place the items inside the stowage bags and/or place the stowage bags in the tonneau area.

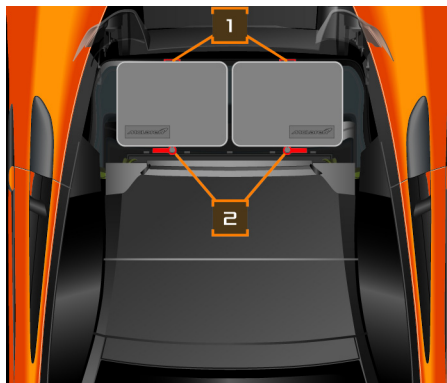

5. Ensure the McLaren logos are facing towards the rear bulkhead and outboard of the vehicle.
6. Attach the carry handle (1) to the fixing area.
7. Attach the secondary loop (2) to the secondary fixing point.

i NOTE: Zip the stowage bags fully closed when in use. This will prevent items from falling out and damaging the roof system and/or backlight glass.

i NOTE: Ensure the stowage bags are securely fitted when in use and are attached to all the location points.

Before You Drive Stowing Luggage

Removing and storing the stowage bags

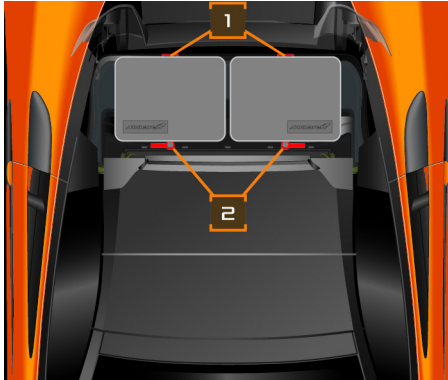

1. Detach the carry handle (1) from the fixing area.
2. Detach the securing loop (2) from the secondary fixing point.
3. Remove the stowage bag from the tonneau area and remove the contents.
4. Place the empty stowage bag on a flat surface with the McLaren logo facing downwards.
5. Fold in the thinner portion of the stowage bag, followed by the thicker portion and then turn the stowage bag over.

6. With the McLaren logo facing upwards, tightly roll the stowage bag and secure by wrapping the toggle around it and under the locating point.
7. Place the stowage bag in the tonneau area into the stowage mounts, ensuring it is secure by placing the securing strap over the stowage mount.

i NOTE: This process is detailed on a label attached to the inner surface of the tonneau cover.

i NOTE: Make sure the stowage bags are fitted to the stowage mounts when not in use.

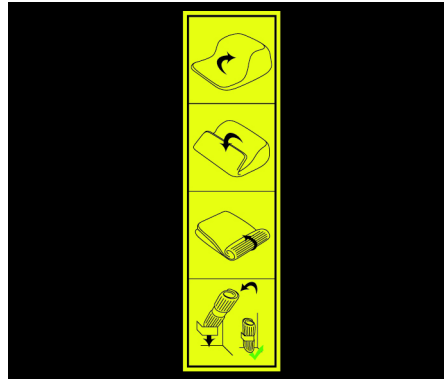

8. Repeat the process for the second stowage bag.

Before You Drive

Anti-Theft System

Alarm system

A visual and audible alarm is triggered if the alarm system is armed and any of the following are opened:

- a door
- the service cover
- the luggage compartment lid
- the tonneau cover (Spider only)

i NOTE: The alarm remains triggered even if you close the open aperture. To silence the alarm, unlock the vehicle.

The alarm system also incorporates the following features:

- tow-away protection
- interior motion sensor
- centre console stowage compartment

i NOTE: The centre console stowage compartment must be closed for the interior motion sensor or the Auto Alarm to become armed.

Arming the alarm system

1. Lock the vehicle (using the keyless system or the key fob). The anti-theft alarm system will be armed after approximately 5 seconds.



2. The light in the central locking button will illuminate for approximately 60 seconds after locking the vehicle

Disarming the alarm system

1. Unlock the vehicle (using the keyless system or the key fob), the alarm will disarm and the light in central locking button will stop flashing.

Immobiliser

The immobiliser prevents your McLaren from being started by an unauthorised person.

The vehicle is automatically immobilised when it senses that there is no key fob present in the vehicle.

Remobilisation occurs when a key fob is sensed inside the vehicle.

i NOTE: Immobilisation will only occur if the engine is not running

Before You Drive

Anti-Theft System

Tow-away protection

Tow-away protection is designed to prevent any attempt to steal the vehicle by suspended tow or by lifting onto a trailer.

The alarm is triggered if the vehicle is raised or tilted in any way.

Tow-away protection is armed approximately 30 seconds after the vehicle has been locked and is disarmed when the vehicle is unlocked.

Disabling tow-away protection

Disable tow-away protection manually if your vehicle is being transported, e.g. loaded onto a ferry or vehicle transporter or your vehicle is parked on a movable surface, e.g. in a split-level garage.



1. To disable tow-away protection, switch off the ignition, open the driver's door and press the button on the rear edge of the driver's door. The light in the switch will illuminate to indicate that tow-away protection has been disabled.

i **NOTE:** You cannot disable tow-away protection if the ignition is switched on.

2. Close the driver's door and lock the vehicle (using the keyless system or the key fob). Tow-away protection remains disabled until you unlock the vehicle.

Before You Drive

Anti-Theft System

Interior motion sensor

The alarm is triggered if your vehicle is locked and movement is detected inside, e.g. if someone breaks a window or reaches into the vehicle through an open window.

The interior motion sensor is armed approximately 30 seconds after the vehicle has been locked and is disarmed when the vehicle is unlocked.



NOTE: To prevent false alarms close the windows when leaving the vehicle and do not hang anything on the interior mirror.

Disabling the interior motion sensor

Disable the interior motion sensor if people or animals are to remain in the locked vehicle.



1. To disable the interior motion sensor, switch off the ignition, open the driver's door and press the button on the rear edge of the driver's door. The light in the switch will illuminate to indicate that the interior motion sensor has been disabled.



NOTE: You cannot disable the interior motion sensor if the ignition is switched on.

2. Close the driver's door and lock the vehicle (using the keyless system or the key fob). The interior motion sensor remains disabled until you unlock the vehicle.

Before You Drive Seats

Safety

⚠ WARNING: Adjust the driver's seat when the vehicle is stationary. You may not be able to observe road and traffic conditions and you could lose control of the vehicle as a result of the seat moving. You could therefore cause an accident.

⚠ WARNING: The seats can be moved even without a key fob in the vehicle. Do not leave children unattended in the vehicle, they could be injured if a seat is moved accidentally.

⚠ WARNING: Ensure that no one can become trapped as the seat moves.

To reduce the risk of injuries in the event of an accident, observe the following:

- All vehicle occupants must select a seat position that allows the seat belt to be worn correctly, but is as far away from the front air bags as possible. The position of the driver's seat must allow the driver to drive the vehicle safely. The distance from the driver's seat to the pedals

must be such that the driver can fully depress the pedals. The distance between the driver's chest and the centre of the air bag cover must be more than 25 centimetres (10 inches). The driver's arms should be slightly bent when holding the steering wheel.

- Vehicle occupants must always wear their seat belt correctly.
- Position the passenger's seat as far back as is comfortable.

⚠ WARNING: McLaren Automotive does not recommend the use of child seats in this vehicle, but if you choose to do so, please follow the guidelines below:

- Children under 1.5 metres (4 ft 11 in) tall or younger than 12 years of age must be secured in a suitable child restraint.
- If you are using a child restraint on the passenger's seat, move the seat as far back as possible.

Manual seats

Manual seat forward and rearward adjustment



Lift the lever, move the seat to the desired position and release the lever to lock the seat.

⚠ WARNING: Ensure the seat is locked in position before driving.

i NOTE: Ensure that there are no items of luggage in the footwell or behind, underneath or to the side of the seats. This may lead to the seats being damaged.

Before You Drive Seats

Manual seat backrest rake adjustment

! **WARNING:** To minimise the risk of injury, position the backrest as close as possible to vertical.

i **NOTE:** Do not recline the seat backrest so that it repeatedly contacts the rear bulkhead as this could lead to damage over time.



Lift the lever, move the seat backrest to the position required, and release the lever.

Manual seat height adjustment



Press the switch up or down until the seat reaches the desired height.

i **NOTE:** Height adjustment is only available on the driver's seat.

Racing seats

Seat Forward and Rearward Adjustment

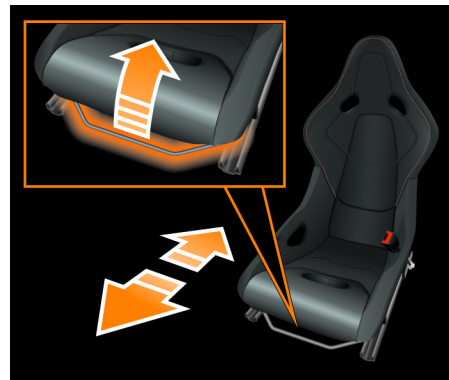

i **NOTE:** It is only possible to adjust the forward and rearward position of the seat.

To adjust the seat, lift the lever and slide the seat to the desired position, ensuring you can comfortably reach all pedals and are able to move them through their full travel.

! **WARNING:** Ensure the seat is locked in position before driving.

Before You Drive Seats

i NOTE: Ensure that there are no items of luggage in the footwell or adjacent to the seats as this may lead to the seats being damaged or not getting full adjustment.

Seat Height and Tilt Adjustment

For seat height and tilt adjustment, contact your McLaren retailer.

! **WARNING: Seat height adjustment should only be carried out by your McLaren retailer.**

Electric seats

Electric seat adjustment

The seat adjustment switches are on the side of the seat base and can be used when the vehicle is in any awake status, see Vehicle electrical status, page 2.2.

i NOTE: Ensure there are no items of luggage in the footwell or behind, beneath or to the side of the seats, or the seats may be damaged.

Forward and rearward adjustment

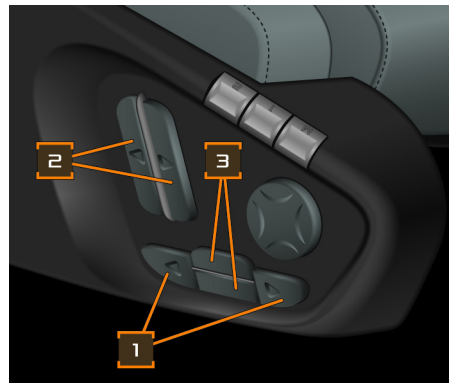

Press the switches (1) until the seat reaches the desired position.

Before You Drive Seats

Electric seat backrest rake adjustment

⚠ WARNING: To minimise the risk of injury, position the backrest as close as possible to vertical.

i NOTE: When reclining the backrest, the seat base will automatically move forward, depending on its position relative to the rear bulkhead. If the seat base is moved backwards when the backrest is fully reclined, the backrest will automatically raise to prevent contact with the rear bulkhead.

i NOTE: Do not recline the seat backrest so that it repeatedly contacts the rear bulkhead as this could lead to damage over time.

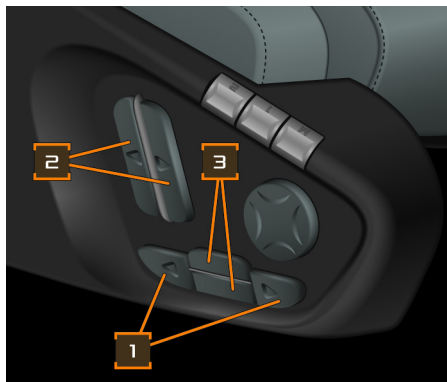

Press the switches (2) until the backrest is in the required position.

⚠ WARNING: Ensure there are no items beneath the passenger's seat or the occupant classification system may not function correctly.

Electric seat height adjustment

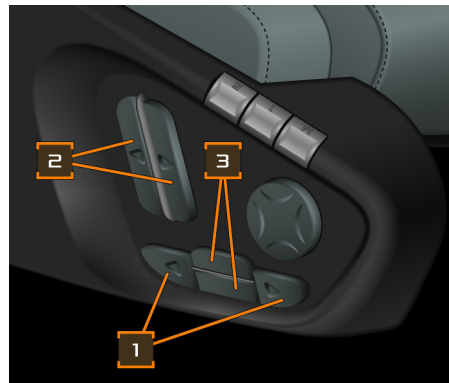

Press the switches (3) until the seat reaches the desired height.

Before You Drive Seats

Electric seat lumbar adjustment

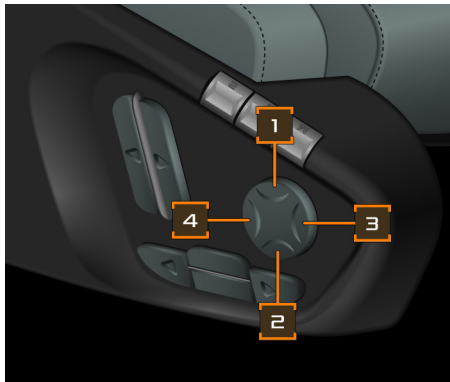

Press (1) to raise or (2) to lower the position of the lumbar support.

Press (3) to inflate or (4) to deflate the lumbar support.

Storing a memory position

Specific seat, exterior mirror, and steering wheel positions can be stored for up to two drivers.

- i** NOTE: Exterior mirror and steering wheel positions can only be stored or recalled using the driver's memory buttons.
- i** NOTE: Steering wheel position can only be stored or recalled if electric steering column is fitted.



Set the seat, mirrors, and steering wheel to the desired positions; see Electric seats, page 1.33, Electric steering wheel adjustment, page 1.38 and Exterior mirrors, page 1.50.

Press and hold the memory set button (1) and then simultaneously press one of the memory position buttons (2) to store the setting.

Recalling a memory position

⚠ WARNING: Only recall a seat, mirror, and steering wheel position, when the vehicle is stationary. You may not be able to observe road and

Before You Drive Seats

traffic conditions this could lead to you losing control of the vehicle which may result in an accident.

i NOTE: Exterior mirror and steering wheel positions can only be stored or recalled using the driver's memory buttons.

i NOTE: Steering wheel position can only be stored or recalled if electric steering column is fitted.

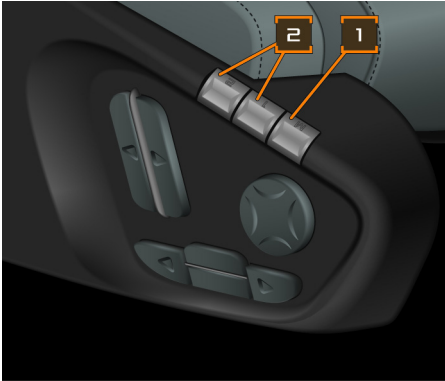

Press the button (2) where the required setting is stored, and hold until the seat, exterior mirrors and steering wheel have completed their adjustment.

Comfort exit

⚠ WARNING: Ensure that no one can become trapped as the seat moves.

When comfort entry/exit is active, the driver's seat will move fully rearwards and to its lowest position and the steering wheel will move inwards and to its highest position when the engine is off and the driver's door is opened.

This assists exit from the vehicle. To switch the feature on or off, see Comfort Entry/Exit, page 3.23.

i NOTE: Steering wheel will only change position if electric steering column is fitted.

Comfort entry

After entering the vehicle, you can return the driver's seat and steering wheel to its most recent position using the control stalk on the left of the steering column.

i NOTE: Steering wheel will only change position if electric steering column is fitted.

The function will only be available when 'Comfort Entry available Pull left stalk to activate Press OK to cancel' is displayed on the instrument cluster.

The vehicle must be awake with ignition off, the driver's door closed, and comfort entry/exit ON.

1. Pull the control stalk towards you once to initiate the comfort entry function.
2. If at any point you wish to cancel the function, operate the control stalk or open the driver's door. A message 'Comfort Entry returning Operate stalk or open door to abort' will appear on the instrument cluster.

i NOTE: This function will only return the seat and steering wheel to the position they were in prior to the comfort entry/exit function being used. It will not use any of the memory positions, unless the previous position was one of the stored memory positions.

3. If the seat or steering wheel are manually adjusted before the stalk is used, the function will be lost and will not be available until the next time comfort entry/exit function is used.

Before You Drive

Seats

-  NOTE: Cancel the comfort entry/exit function by starting the engine, or by pressing a seat or steering column switch while the seat is returning to position.
- 4. If the comfort entry/exit function is cancelled, it will not be possible to return the seat and steering wheel to their previous positions using this function. The message on the instrument cluster will disappear and the control stalk will return to its normal use. The function will be available when comfort entry/exit is next used.
- 5. Once the seat and steering wheel have returned to their previous positions, the message on the instrument cluster will disappear and an audible alert will confirm that the process has been completed.

Heated seats

Heated seats can be accessed using the climate control screen on IRIS. See Heated seats, page 4.10.

-  NOTE: The heated seat function is only available when the engine is running.

Before You Drive

Steering Wheel and Steering Column

Manual steering wheel adjustment

⚠ WARNING: Only adjust the steering wheel position when the vehicle is stationary. You may not be able to observe road and traffic conditions this could lead to you losing control of the vehicle which may result in an accident.

The steering wheel can be adjusted for height and reach.

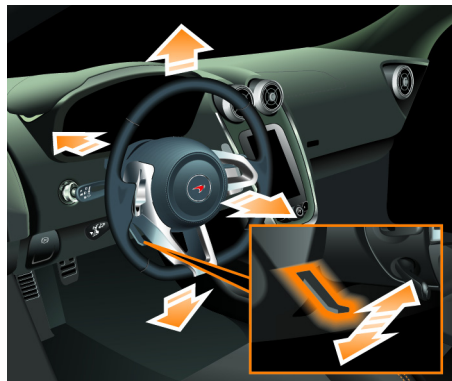

Push the lever (highlighted) downwards and position the steering wheel so that:

- your arms are slightly bent when you hold the wheel
- you can move your legs freely
- you can see all the displays on the instrument cluster clearly

Pull the lever up to secure the steering wheel. Ensure the lever is locked before driving.

Electric steering wheel adjustment

⚠ WARNING: Only adjust the steering wheel position when the vehicle is stationary. You may not be able to observe road and traffic conditions this could lead to you losing control of the vehicle which may result in an accident.

The steering wheel position may be adjusted for height and reach using the column control switch when the vehicle is in any awake status, see Vehicle electrical status, page 2.2.

The column control switch is located on the left-hand side of the steering column.

Before You Drive

Steering Wheel and Steering Column

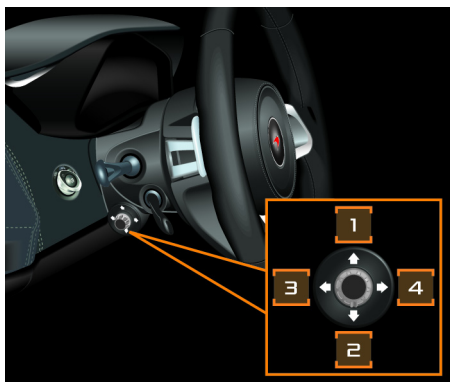

1. Height: Raise
2. Height: Lower
3. Reach: Away
4. Reach: Towards

Moving the column control switch in directions 1 & 2 adjusts the steering wheel height, raising or lowering the wheel's position.

Moving the column control switch in directions 3 & 4 adjusts the steering wheel reach, moving it closer or further away.

i NOTE: The column control switch will only adjust the steering wheel in one direction at a time.

Using the column control switch, position the steering wheel so that:

- your arms are slightly bent when you hold the wheel
- you can move your legs freely
- you can see all the displays on the instrument cluster clearly

Automatic steering wheel adjustment

If your vehicle is equipped with electric seats, the electric steering wheel position is stored when the seat and mirror positions are stored. See Storing a memory position, page 1.35.

! WARNING: Ensure that your hands are kept clear of the wheel and column as the steering wheel moves.

i NOTE: Any automatic movement can be cancelled with any input from the column control switch.

Comfort entry/exit

When comfort entry/exit is active, the steering wheel and column will move fully inwards (away from the driver) and to its highest position when the engine is off and the driver's door is opened.

You can return the steering wheel and column to its most recent position using the control stalk on the left of the steering column. See Comfort exit, page 1.36.

! WARNING: Ensure that your hands are kept clear of the wheel and column as the steering wheel moves.

i NOTE: Any automatic movement can be cancelled with any input from the column control switch.

Before You Drive

Steering Wheel and Steering Column

Horn

Press the centre of the steering wheel to operate the horn.

 **NOTE:** The horn can be operated when the ignition is switched off.

Before You Drive

Occupant Safety

Seat belts

Seat belts and child restraint systems are the most effective means of restraining vehicle occupants from impact forces, which minimises the danger of injury from interior impacts and the effects of whiplash.

 **WARNING: A seat belt which is not worn, worn incorrectly, or has not been engaged fully in the seat belt buckle, cannot perform its intended function. To avoid injuries, ensure that all vehicle occupants wear their seat belt correctly at all times.**

Ensure that the belt:

- is routed as low as possible across your pelvic area, i.e. across your hip joints and not across your abdomen
- fits closely
- is not twisted
- is routed across the middle of your shoulder
- lies flat across the mid point of the collar bone between the neck and shoulder
- fits closely across your pelvis by pulling the shoulder belt upwards

Do not secure any objects with a seat belt if the seat belt is being used by a vehicle occupant.

Avoid wearing bulky clothing.

Do not route the belt across sharp edged or fragile objects especially if these are on or in your clothing. The seat belt could be damaged and you could be injured.

Only one person should use each seat belt at any one time.

Never allow children to travel on the lap of another occupant.

Children under 1.5 metres (4 ft 11 in) tall or younger than 12 years of age must be secured in a suitable child restraint. Follow the manufacturer's instructions when installing child restraint systems.

 **WARNING: Pregnant women should wear a seat belt to ensure maximum safety of mother and unborn child. Position the lap belt across the hips, beneath the abdomen and position the shoulder belt between the**

breasts and to the side of the abdomen. Ensure the belt is not slack or twisted.

 **WARNING: The seat belt only provides its intended degree of protection if the seat backrest is positioned close to vertical, and the occupant is sitting upright.**

 **WARNING: The seat belt cannot perform its function correctly if the seat belt or buckle becomes excessively dirty or damaged. Ensure the belt latch engages the buckle fully.**

Check the seat belts regularly to ensure that they are not damaged, or routed over sharp edges and are not trapped. The belt could tear in an accident, causing injury to occupants.

Have seat belts checked if the belts have been damaged or subjected to a heavy load. Work on the seat belts should only be carried out by your McLaren retailer.

Before You Drive

Occupant Safety

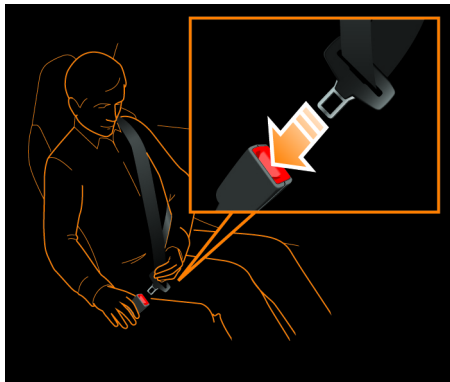

Wearing a seat belt



1. Ensure that you are seated comfortably and the controls are within easy reach.
2. Grasp the seat belt latch and pull across the body, ensuring that the belt lies flat across the mid point of the collar bone between the neck and shoulder, then across the chest and pelvis.
3. With the belt correctly positioned insert the latch into the buckle and press until a click is heard to confirm engagement. Check engagement by attempting to pull the latch from the buckle.

Seat belt tensioners

The seat belts incorporate belt tensioners. Belt tensioners apply tension to the seat belts in an accident, pulling them tight against the occupant.

-  **WARNING: Do not insert the belt latch into the passenger's seat belt buckle if the passenger's seat is unoccupied. The belt tensioners could be triggered in an accident.**
-  **WARNING: Belt tensioners do not correct an incorrect seating position or incorrectly worn seat belts.**

Belt tensioners do not pull occupants back towards the backrests.

The belt tensioner will be triggered for each seat belt, provided the belt latch is engaged in the seat belt buckle, if a head-on or rear-end collision occurs and the vehicle decelerates or accelerates rapidly.

If the belt tensioners are triggered, a bang will be heard, a small amount of dust may be released and the Supplementary Restraint System warning light will illuminate.

 **WARNING: Once triggered (or if you are unsure if they have triggered) you MUST not drive the vehicle. Contact your nearest McLaren retailer immediately.**

Belt force limiters

The seat belts incorporate belt force limiters. Belt force limiters are tuned to the front air bags and gradually release the tension being applied to the belts during an impact, reducing the force exerted on occupants.

Before You Drive

Occupant Safety

Seat belt warning light



The seat belt warning light in the instrument cluster and a warning tone reminds vehicle occupants to fasten their seat belts. The seat belt warning light extinguishes and the warning tone ceases when the driver and passenger have fastened their seat belt.

Supplementary Restraint System

Air bag system

Your McLaren is equipped with the following air bags:

- driver's front air bag in the steering wheel
- passenger's front air bag in the dashboard
- side head air bags in the doors



WARNING: Air bags are not a substitute for correctly worn seat belts, they enhance the level of occupant protection offered by seat belts.



WARNING: Correct operation of the air bags can only occur if the steering wheel, the passenger's air bag cover and the door trim are not covered.



WARNING: To reduce the risk of injuries in the event of an accident, observe the following points:

- Ensure that the driver's chest is at least 25 centimetres (10 inches) from the air bag cover.

- Do not lean forward over the dashboard while the vehicle is in motion.
- Do not rest your feet on the dashboard.
- Only hold the steering wheel by the outside of the rim. You could be injured if the air bag deploys and you are holding the inside of the steering wheel.
- Occupants, particularly children, must not lean on the doors from inside the vehicle.
- Ensure that there are no other objects between the vehicle occupants and the deployment area of the air bags.
- Because of the high speed at which air bags deploy, there is a risk of injuries caused by an inflating air bag.

Air bag replacement



WARNING: McLaren recommends that air bags are replaced every 15 years to prevent air bags from not firing due to component operating life.

Before You Drive

Occupant Safety

Air bag system modification

If it is necessary to modify the air bag system to accommodate a person with disabilities, please contact your nearest McLaren retailer. For more information on McLaren retailers, please refer to your Service and Warranty Guide.

Front air bags



The driver's front air bag (1) deploys in front of the steering wheel and the passenger's front air bag (2) deploys in front of and above the dashboard.

The front air bags are deployed if the system determines they can offer additional protection for occupants against head and chest injuries.

i NOTE: The passenger's front air bag is only triggered if the PASSENGER AIR BAG OFF warning light on the overhead console is NOT illuminated, see Occupant classification system - front passenger's seat, page 1.45.

Side head air bags

! WARNING: To reduce the risk of injury to occupants if a side head air bag is triggered, ensure that:

- there are no other objects between the vehicle occupants and the deployment area of the air bags
- no accessories are attached to the doors
- no heavy or sharp objects are left in the pockets in clothing
- occupants, particularly children, must not lean on the doors from inside the vehicle

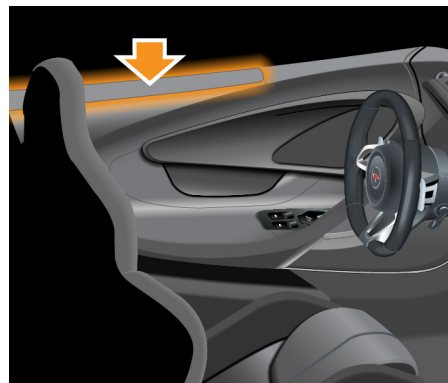

The side head air bags (left-hand highlighted) are located in the upper area of each door panel, and are deployed if the system determines they can offer additional protection for the head of the occupant on the side of the vehicle on which the impact occurs.

i NOTE: The passenger's side head air bag is only deployed if the passenger's seat is occupied.

Before You Drive

Occupant Safety

Occupant classification system - front passenger's seat

The system can determine if the passenger's seat is occupied using a capacitance mat fitted in the seat base, and by checking the seat belt buckle engagement on the passenger's seat belt. The system will deactivate the passenger's front air bag for children in child seats and unoccupied passenger's seat ensuring air bag deployment for adults.



The status of the air bags is indicated by the PASSENGER AIR BAG OFF warning light on the overhead console.

The PASSENGER AIR BAG OFF warning light illuminates when the ignition is switched on and extinguishes after 5 seconds.

The warning light will remain illuminated if the passenger's seat is unoccupied or if a child seat is fitted.

i NOTE: The PASSENGER AIR BAG OFF warning light is always illuminated unless the passenger's seat is occupied by an adult.

If the PASSENGER AIR BAG OFF warning light is illuminated, the passenger's front air bag is not active. The side head air bag and the belt tensioner on the passenger's side remain active even if the PASSENGER AIR BAG OFF warning light is illuminated.

! WARNING: If the PASSENGER AIR BAG OFF warning light is not illuminated when the child seat is fitted, the passenger's air bag is not deactivated. The child could be seriously injured if the passenger's air bag inflates.

! WARNING: To ensure that the occupant classification system functions correctly, McLaren recommends that objects are not

placed under a seat. McLaren also recommends that additional materials are not applied such as a blanket, cushion, or aftermarket equipment such as a seat cover, heater, or massager. These items can seriously affect how well the occupant classification system operates. McLaren recommends that aftermarket equipment such as covers, heaters, and massagers are NOT used.

! WARNING: Any electronic devices that are either active or connected to the 12 V accessory socket should not be placed on the passenger's seat. They can affect how the occupant classification system operates.

! WARNING: The occupant classification system may become affected if any form of liquid (inclusive of rain) is spilled onto the passenger's seat. If the PASSENGER AIR BAG OFF warning light is not illuminated when the seat is unoccupied, do not install a child restraint or allow anyone to occupy

Before You Drive

Occupant Safety

the seat. Please contact your nearest McLaren retailer at your earliest convenience.

 **WARNING: Do not place sharp objects onto the passenger's seat. These may damage the occupant classification system if they puncture the seat cushion.**

 **WARNING: To ensure that the occupant classification system functions correctly, never place objects (e.g. a cushion) under the child restraint system. The entire base of the child restraint system must be in contact with the seat at all times. If a child restraint system is not fitted correctly it may not provide the intended degree of protection in the event of an accident and may cause injuries.**

Air bag deployment

In the event of a collision the air bags are deployed by the Supplementary Restraints System to protect the vehicle occupants. The system can control the number of air bags deployed and partially or fully inflate

the air bags depending on the severity of the collision to provide the best possible protection to the vehicle occupants.

The system uses sensors to rapidly evaluate the collision severity and the number of vehicle occupants. Once all these factors are known the system will then deploy the necessary air bags and regulate the inflation pressure in the impact zone to ensure the occupant's safety.

After an accident the air bags begin to depressurise almost immediately after the inflation process has taken place. The gas used to inflate the air bags escapes through vents in the air bag and this helps reduce the occurrence of major impact injuries to the occupants.

An air bag slows down and restricts the movement of the vehicle occupant reducing the load on the body, but is not a substitute for a correctly worn seat belt.

 **WARNING: If the air bags are deployed, a bang will be heard and a small amount of fine powder may be released. The noise will not damage your hearing and the powder does not constitute a health hazard nor does it imply that a fire has broken**

out. This powder could cause short term breathing difficulties for persons suffering from asthma or other respiratory conditions. To prevent breathing difficulties, leave the vehicle as soon as possible or open a window.

 **WARNING: After an air bag has been triggered, air bag parts are hot, do not touch them. Have the air bags replaced at your McLaren retailer.**

Out Of Position (OOP)

The air bag system in your McLaren has been tested for the correct small child Out Of Position (OOP) operation. OOP can occur if a small child is incorrectly positioned in the passenger's seat in the event of a collision in which the air bags are deployed.

Supplementary Restraint System warning light

 The Supplementary Restraint System performs a self-test at regular intervals when the ignition is switched on and the engine is running.

Before You Drive

Occupant Safety

The warning light in the instrument cluster illuminates when the ignition is switched on and extinguishes 5 seconds after the engine is started.

 **WARNING: Contact your McLaren retailer immediately should any of the following occur:**

- the warning light does not illuminate when you switch on the ignition
- the light does not extinguish 5 seconds after the engine is running
- the light illuminates again, after the engine has started

Safety features

If you are unfortunate enough to be involved in an accident the following events will occur to assist you and any recovery personnel:

- the doors will unlock
- the hazard warning lights will switch on
- the interior lighting will switch on

In some instances, the fuel system will also be switched off.

Child passengers

 **WARNING: Do not leave children unsupervised in the vehicle even if they are secured in a child restraint. Children could injure themselves on parts of the vehicle, open a door and be seriously or even fatally harmed by prolonged exposure to heat or cold.**

If children open a door, they could cause injury to others in doing so or get out of the vehicle and possibly injure themselves or they could be injured by a passing vehicle.

Do not expose the child restraint system to direct sunlight. The metal parts of the child restraint system could burn the child.

Do not carry heavy or hard objects inside the vehicle unless they are secured.

An unsecured or incorrectly positioned load increases the risk of injury to the child during sharp braking, a sudden change of direction or an accident.

Before You Drive

Occupant Safety

Child restraint system

McLaren Automotive does not recommend the use of child seats in this vehicle, but if you choose to do so, please follow the guidelines below:

Secure any child under 1.5 metres (4 feet 11 inches) tall or younger than 12 years of age travelling in the vehicle in an appropriate category restraint according to their weight. Contact your McLaren retailer for advice.

Please refer to current national and local laws for specific requirements.



 **WARNING:** Never secure a rearward facing child restraint system on the passenger's seat if the passenger's front air bag is active. The status is indicated by the PASSENGER AIR BAG OFF indicator.



 **WARNING:** If the PASSENGER AIR BAG OFF indicator does not illuminate, do not use a rearward facing child restraint system on the passenger seat. You may use a forward-facing child restraint system on the passenger's seat. The warning label on the passenger's side is there to remind you of this.

 **WARNING:** If a forward facing child seat is fitted to the passenger's seat, make sure that the passenger's seat is fully rearwards

Before You Drive

Occupant Safety

and is positioned at the lowest height. A manual passenger's seat does not have height adjustment.

 **WARNING: If the child restraint system has not been fitted correctly, the child cannot be restrained in an accident or sudden braking and could be injured. When fitting a child restraint system, observe the manufacturer's instructions on the correct use of the child restraint.**

KISI child restraint function

Your McLaren is fitted with a KISI system which is an automatic locking seat belt on the passenger's side designed to temporarily lock the seat belt to securely hold the child restraint in the passenger's seat.

1. Extend the passenger's seat belt fully. The KISI system only engages when the seat belt is fully extended.

 **NOTE: If the vehicle is parked on a hill the inertia lock may stop the seat belt extending. If this occurs, release the seat belt slightly and continue to extend the seat belt carefully to avoid the engagement of the inertia lock.**

2. Pass the seat belt through the child restraint as described by the child restraint manufacturer and engage the belt latch in the buckle.
3. Adjust the belt so that the lower section is tight against the restraint and allow the upper section to retract. The KISI system will click as the belt retracts.
4. When the seat belt has retracted as far as possible, pull on the upper section to check that the seat belt has locked.

 **NOTE: The KISI system will disengage when the seat belt has fully retracted and can then be worn as a normal seat belt. Once the KISI system has unlocked, it will be necessary to fully extend the seat belt to engage the KISI system the next time a child restraint is used.**

Before You Drive Mirrors

Safety

 **WARNING:** Before driving, adjust all mirrors to give the best possible view of road and traffic conditions.

Interior mirror



The automatic dimming function of the interior mirror is activated or deactivated by pressing the switch (2) on the bottom of the mirror. The indicator light (1) will illuminate when automatic dimming is active.

When activated, the interior mirror will automatically dim when bright light is detected by the light sensor (3).

If reverse gear is selected or if ambient light levels are high, the automatic dimming function will be deactivated.

Exterior mirrors

 **WARNING:** In some markets, the exterior mirrors have convex glass fitted. This type of mirror enlarges the field of vision, but reduces the size of the image. This means that objects are closer than they appear.

To avoid misjudging the distance to vehicles travelling behind and perhaps causing an accident, check the actual distance of the vehicle, before changing direction.

The exterior mirrors control is located on the dashboard between the steering wheel and the centre console.

Before You Drive

Mirrors

Adjusting mirrors

1. Switch the ignition on.

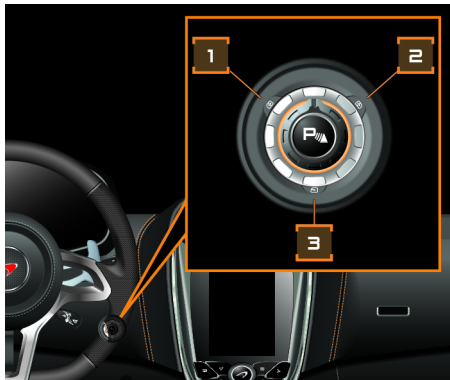

2. Rotate the control to the left (1) to adjust the left-hand mirror or to the right (2) to adjust the right-hand mirror.
3. Move the control up, down left and right to adjust the mirror to the desired position.

Exterior mirror fold

1. Switch the ignition on.
2. Rotate the control to position (3) to fold the mirrors.
3. To unfold the mirrors rotate the control away from position (3).

i NOTE: If the switch remains in position (3) the mirrors will be folded until the switch is moved.

Exterior mirror automatic fold

The exterior mirrors can be set so that they fold automatically when the vehicle is locked. Unfolding occurs as a door is opened, not when the vehicle is unlocked. See Auto Fold Mirrors, page 3.23.

Mirror dipping in reverse

The exterior mirrors can be set to dip when reverse is engaged. This provides a view of the ground to the rear of the vehicle. See Reverse Mirror Dip, page 3.24.

Heated mirrors

Exterior mirrors are heated when the switch is pressed on the IRIS screen and the engine is running. see Heated mirror, page 4.11. They are also heated when the ambient temperature is below 5°C (41°F).

Before You Drive Lighting

Exterior lighting

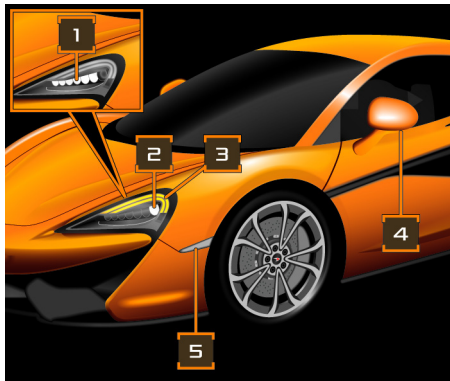

1. Headlamp main beam
2. Headlamp dipped beam
3. Direction indicator/Sidelamp/Daytime running lamp (except Japan)
4. Side direction indicator
5. Side marker lamp/bezel

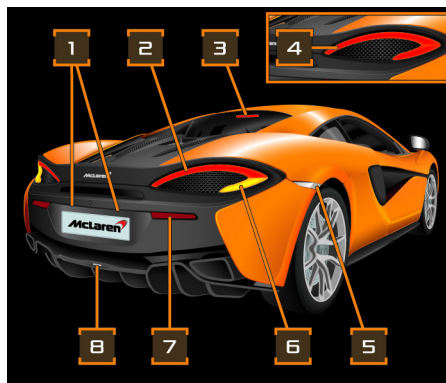

Coupe

1. Licence plate lamp
2. Stop lamp
3. Central high mounted stop lamp
4. Tail lamp
5. Side marker lamp/bezel
6. Direction indicator
7. Reflector
8. Reverse lamp and rear fog lamp

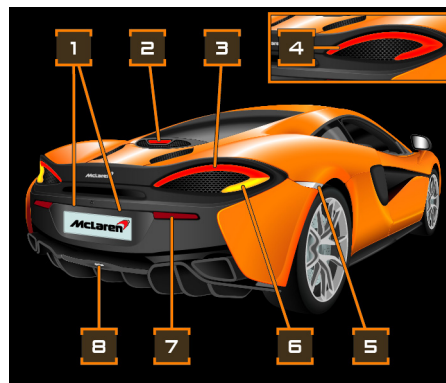

GT

1. Licence plate lamp
2. Central high mounted stop lamp
3. Stop lamp
4. Tail lamp
5. Side marker lamp/bezel
6. Direction indicator
7. Reflector
8. Reverse lamp and rear fog lamp

Before You Drive Lighting

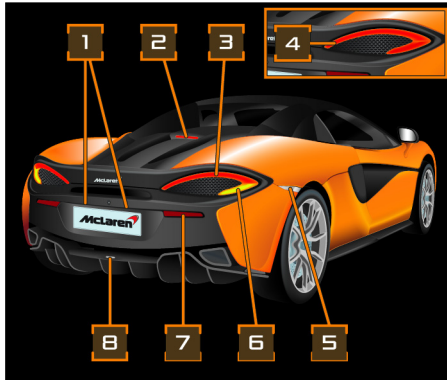

Spider

1. Licence plate lamp
2. Central high mounted stop lamp
3. Stop lamp
4. Tail lamp
5. Side marker lamp/bezel
6. Direction indicator
7. Reflector
8. Reverse lamp and rear fog lamp

Before You Drive

Lighting

Light switch

WARNING: The lights do not switch on automatically in foggy conditions.

Automatic light control is only an aid, you are responsible for the vehicle's lighting at all times.

The light switch is located between the steering wheel and the driver's door and has the following positions.

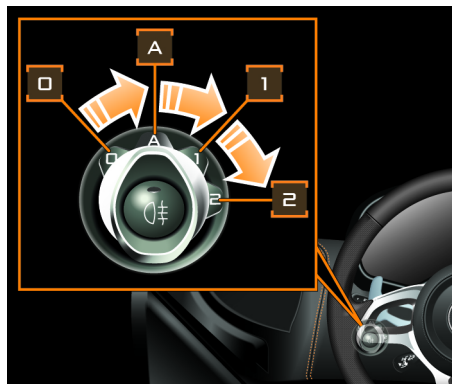

At position (0), the lights are off with the exception of daytime running lamps (except Japan) and tail lamps.

Rotate the control to position (A) for automatic light control.

Rotate the control to position (1) for sidelamps or position (2) for headlamps. The sidelamp warning light illuminates in the instrument cluster.

Automatic light control

The sidelamps and dipped beam headlamps are switched on automatically when ambient light falls below a predetermined level.

To switch on automatic light control, turn the light switch to position (A).

- i** NOTE: If the vehicle detects rain whilst the light switch is set to position (A) the dipped beam headlamps will switch on automatically, regardless of current external light levels.
- i** NOTE: With the light switch in position (A) and the fog lights switched on, the dipped beam headlamps will also switch on irrespective of ambient light conditions. When the rear fog lamps are switched off, the dipped beam headlamps will also switch off dependent on ambient light conditions.

Before You Drive

Lighting

Sidelamps

The sidelamps and the daytime running lamps (except Japan) are a combined series of Light Emitting Diodes located around the outside of the headlamp. The sidelamps operate at a lower intensity than the daytime running lamps, see Daytime running lamps (except Japan), page 1.56.

The sidelamps, tail lamps and licence plate lamps illuminate when the light switch is turned to position (1).



The sidelamps warning light in the instrument cluster illuminates.

Dipped beam headlamps

To switch on the headlamps, turn the light switch to (2).



NOTE: On your McLaren, the same headlight dipped beam setting applies for driving on either the left-hand or right-hand side of the road.

Main beam headlamps



To switch to main beams, push the stalk away from you.



The main beam headlamps warning light illuminates in the instrument cluster.

Pull the stalk towards you, to revert to dipped beams.

Headlamp flash

Pull the stalk fully towards you.

The main beam headlamps operate for as long as the stalk is held.



The main beam headlamps warning light illuminates in the instrument cluster.

Before You Drive

Lighting

Daytime running lamps (except Japan)

Your McLaren is fitted with daytime running lamps which, along with the tail lights, illuminate automatically when the ignition is switched on even if all lights are switched off. The sidelamps and the daytime running lamps are a combined series of Light Emitting Diodes located around the outside of the dipped beam headlamp. The daytime running lamps operate at a higher intensity than the sidelamps.

Rear fog lamp

i NOTE: The rear fog lamp only operates when dipped beam headlamps are on.

Ensure that the dipped beam headlamps are switched on or the light switch is in position (A).

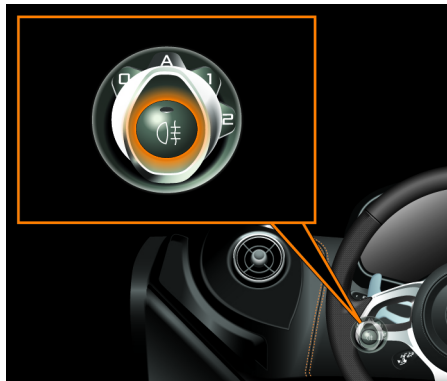

Press the fog light button in the centre of the light switch.

☖ The warning light in the instrument cluster and the light in the switch both illuminate.

i NOTE: With the light switch in position (A) and the rear fog lights switched on, the dipped beam headlamps will also switch on irrespective of ambient light conditions. When the rear fog lamps are switched off, the dipped beam headlamps will also switch off dependent on ambient light conditions.

Before You Drive Lighting

Direction indicators

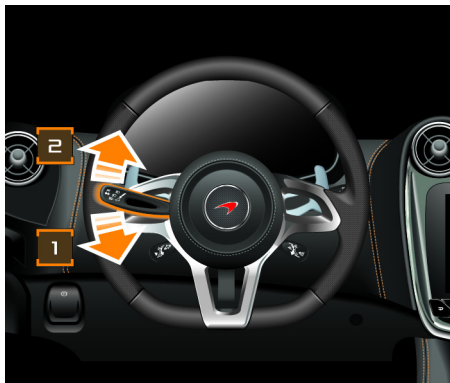

Push the direction indicator/main beam stalk downwards (1) to switch on the left-hand direction indicator.

Push the direction indicator/main beam stalk upwards (2) to switch on the right-hand direction indicator.

 The corresponding warning light in the instrument cluster will flash.

The stalk returns to its rest position as the steering wheel returns to its central position.

Direction indicators - lane change

Move the direction indicator/main beam stalk until resistance is felt when changing lanes on a motorway. The appropriate direction indicator flashes three times.

For further information about the lighting see Light switch, page 1.54.

Hazard warning lamps

The hazard warning lamps operate even if the ignition is switched off. As a safety feature, they switch on automatically when an air bag is triggered.

Operating the hazard warning lamps



1. Press the hazard warning lamps button.
2. All the direction indicator lamps and both direction indicator warning lights in the instrument cluster flash.
3. Press the hazard warning lamps button again to switch off.

Before You Drive Lighting

i NOTE: If the hazard warning lamps have been switched on automatically, press the hazard warning lamps button once to switch them off.

Panic alarm

The panic alarm function is designed to attract attention by sounding the horn and flashing the direction indicator lamps repeatedly.

The panic alarm can be switched on by pressing the hazard warning lamps button for a period of 3 seconds or more.

The horn will cease after the panic alarm has been active for a long period of time, but the direction indicator lamps will continue to flash. The horn can be re-initiated by pressing the hazard warning lamps button for a period of 3 seconds or more.

To switch the panic alarm off, press the hazard warning lamps button briefly.

Parking lights



i NOTE: The parking lights can only be activated when the ignition is switched off.

1. To activate the parking lights, press the direction indicator/main beam stalk down for the left-hand side or push up for the right-hand side until resistance is felt. The selected parking lights will illuminate once the vehicle has been locked.
2. To deactivate the parking lights, press the direction indicator/main beam stalk down for the left-hand side or push up

for the right-hand side until resistance is felt. The selected parking lights will then be deactivated.

i NOTE: This will allow parking lights on both sides to be active at same time, and also allows one side to be deactivated, whilst keeping the opposite side activated.

Before You Drive

Washers and Wipers

Windscreen wipers



1. Windscreen wipers off
2. Automatic wipe
3. Slow wipe
4. Fast wipe

i NOTE: Switch off the windscreen wipers in dry weather, dirt can cause inadvertent wiper sweeps which could damage the wiper blades or windscreen.

Operating the windscreen wipers

1. Ensure the ignition is switched on.
2. Move the wiper stalk to the required position

i NOTE: If the windscreen wipers are switched on and the vehicle comes to a halt, the windscreen wipers automatically switch to intermittent wipe, until the vehicle moves away.

Automatic wipe

A rain sensor, located on the windscreen behind the interior mirror, measures the quantity of water on the windscreen and operates the wipers at the most appropriate speed.

To select, move the windscreen wiper stalk to the automatic wipe position (2).

The wipers will wipe once. The wipe frequency then depends on how wet the windscreen is.

Only select the automatic wipe position in damp weather conditions or when it is raining.

To adjust the sensitivity of the rain sensor, see Wiper Sensitivity, page 3.25.

Slow wipe

Move the wiper stalk to position (3), to operate the wipers at slow speed.

Return the stalk to position (1) to switch off.

Fast wipe

Move the wiper stalk to position (4), to operate the wipers at fast speed.

Return the stalk to position (1) to switch off.

Single wipe



1. For a slow single wipe, briefly push the wiper stalk and release. The wipers will operate once at slow speed, without washers.

Before You Drive

Washers and Wipers

- For a fast single wipe, push and hold the wiper stalk down. The windscreen wipers will perform a continuous fast wipe until the stalk is released.

Windscreen wash/wipe

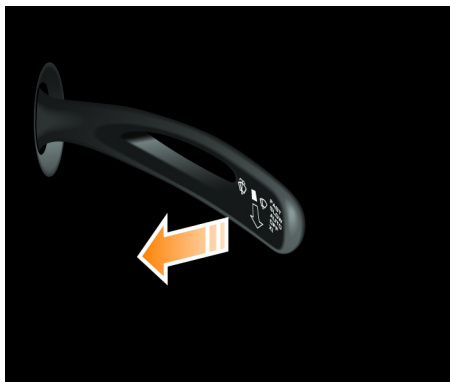

Pull the wiper stalk towards you.

The windscreen washers and wipers will initially operate at a slow speed while the stalk is held. If the stalk is held for more than 2 seconds, the wiper will operate at high speed.

When the stalk is released, the wipers will complete their cycle and return to the parked position. After a period of time the wipers will operate once more to wipe any remaining washer fluid from the windscreen.

i NOTE: The position of the washer jets are set during vehicle manufacture and should not need adjusting. If a problem occurs, consult your McLaren retailer.

Wiper park positions

In addition to the normal park position, there are two alternative positions.

Ensure the vehicle is in accessory mode.

Pull the wiper control stalk towards you, the wipers will move through the following park positions each time the stalk is pulled:

Winter park

The wipers are parked vertically to reduce the risk of damage to the wiper arms during periods of heavy snowfall and provide access for easier cleaning of accumulated snow.

Service park

The wipers are parked diagonally to provide access for replacing the wiper blades, see Replacing the wiper blades, page 5.30.

Normal park

The wipers are parked horizontally along the lower edge of the windscreen.

Before You Drive

Nose Lift

Nose Lift Operation

WARNING: On no occasion should nose lift be used as a jacking system. Using nose lift to access the underneath of the vehicle may result in serious injury.

Nose lift gives you the option to raise or lower the front of the vehicle dependent on the current vehicle ride height.

Nose ride height can only be raised when travelling at speeds below 31 mph (50 kph). The nose will automatically lower at speeds above 37 mph (60 kph).

i NOTE: If the nose lift icon on the instrument cluster is amber, the system is not available. Do not drive the vehicle at high speed and contact your McLaren retailer as soon as possible.

The front suspension can be left fully raised for extended periods, but it may relax to a lower level over time.

If the nose is left in a raised position for a long period, a system reset may occur when the engine is next started to return the nose to normal ride height.

If nose lift is used when in motion, slight adjustments to the steering feel may be experienced, this is normal and does not affect the operation of the vehicle.

Access to nose lift can be obtained by using the menu structure, see Instrument Cluster Display, page 3.4.

Accessing the menu

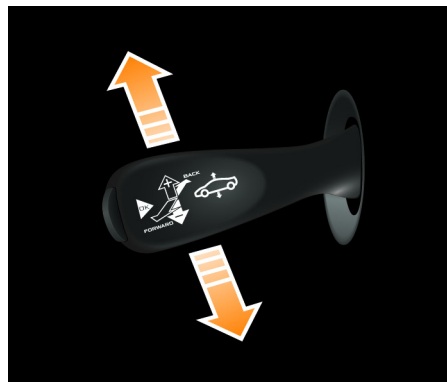

Access to nose lift can be obtained by using the menu control stalk on the left of the steering column, whenever the engine is running and the doors are closed.

i NOTE: Nose lift will be unavailable if launch mode is active.

i NOTE: Nose lift lowering is available only if the door is closed.

Hold the menu control stalk up for one second to quickly access the menu. A confirmation tone will be heard.

Alternatively, access nose lift using the menu structure, see Instrument Cluster Display, page 3.4.

The instrument cluster will exit after the timeout duration has been exceeded back to home screen if there is no activity on the menu.

See Nose Lift, page 3.12, for full information.

McLaren

Driving Controls

| | | | |
|---|-------------|--|-------------|
| Starting and Driving | 2.2 | Hill hold control | 2.30 |
| Vehicle electrical status | 2.2 | Brake-steer | 2.30 |
| Switching on the ignition | 2.3 | Electronic brake pre-fill | 2.30 |
| Instruments and Warning Lights | 2.4 | Electronic stability control | 2.31 |
| Seamless shift gearbox gear positions | 2.6 | Tyre Pressure Monitoring System (TPMS) | 2.34 |
| Parking brake | 2.8 | Cruise Control | 2.37 |
| Brake pedal | 2.9 | Overview | 2.37 |
| Starting/stopping the engine | 2.10 | Using cruise control | 2.37 |
| Driving | 2.12 | Cancelling cruise control | 2.38 |
| Exhaust Temperature Monitoring | 2.14 | Increasing cruise speed | 2.39 |
| Parking Sensors | 2.14 | Reducing cruise speed | 2.39 |
| Rear View Camera (RVC) | 2.16 | Resuming a stored speed | 2.40 |
| Seamless Shift Gearbox | 2.17 | Active Speed Limiter (ASL) | 2.41 |
| Overview | 2.17 | Setting an upper speed limit | 2.41 |
| Gear positions | 2.17 | Running In | 2.42 |
| Accelerator pedal position | 2.18 | Running in | 2.42 |
| Manual/Automatic mode | 2.18 | Normal/Road use | 2.42 |
| Handling and Powertrain Controls | 2.21 | Track use | 2.43 |
| Active dynamics control | 2.21 | Refuelling | 2.44 |
| Active button | 2.21 | Filling with fuel | 2.44 |
| Handling control | 2.22 | Recommended fuel | 2.46 |
| Powertrain control | 2.24 | Winter Driving | 2.47 |
| Launch control | 2.26 | Winter driving | 2.47 |
| Driving Safety Systems | 2.28 | | |
| General | 2.28 | | |
| Anti-lock Braking System | 2.28 | | |
| Brake assist system | 2.29 | | |
| Brake disc wiping | 2.29 | | |

Driving Controls

Starting and Driving

Vehicle electrical status

The vehicle will implement one of the following statuses according to the criteria detailed.

 **NOTE:** The engine can be started from any of the following states, except Locked. If the vehicle is in sleep mode, the START/STOP button will need to be pressed for more than 2 seconds.

 **NOTE:** If the vehicle detects the battery charge is getting too low, it will adopt the Awake status to conserve energy. Accessory and Ignition will be prohibited, but crank will still be available. This is to allow the engine to be started so that battery recharging can commence.

Locked

Vehicle is locked in low power mode.

Sleep

Vehicle is unlocked in low power mode.

Awake

Door is opened or START/STOP button pressed, when the vehicle is in sleep mode.

Time, odometer reading, battery status and fuel gauge are available on the instrument cluster.

If there is no further activity after 2 minutes, the vehicle will return to the sleep status.

Accessory

START/STOP button is pressed, when the vehicle is in Awake mode.

Windows and heater/air conditioning controls operate. IRIS and instrument cluster menus are available.

If there is no further activity after 15 minutes, the vehicle will return to the sleep status.

Accessory mode can also be entered by pressing the OK button on the instrument cluster menu stalk. The key must be present within the cockpit area for this function to be available.

Ignition

START/STOP button is pressed, when vehicle is in Accessory mode.

 **NOTE:** There is no timeout with ignition on. Be aware that the battery could become discharged.

Crank

See Starting/stopping the engine, page 2.10.

Power saving mode

Under very rare circumstances, the vehicle may not be able to supply enough voltage and will activate power saving mode.

 **WARNING: When power saving mode is active, the climate control and steering will operate with reduced effect.**

 **NOTE:** When power saving mode is active, the message 'Battery management active - see owner's manual' appears on the instrument cluster.

Driving Controls

Starting and Driving

Parking days



When the vehicle is unlocked or when the ignition is turned off the number of “days parking” remaining will be displayed on the instrument cluster. This indicates how many days the vehicle can be parked, without running the engine or connecting a battery charger, before the battery will become discharged.

Switching on the ignition

1. Ensure that the key fob is inside the vehicle.



2. To switch on the ignition without starting the engine, press the START/STOP button, without depressing the brake pedal.

i NOTE: If the vehicle is in Awake mode, press the START/STOP button twice with the brake pedal released.

3. The ignition will switch on, the oil temperature, water temperature and fuel gauges will operate and several of

the warning lights will illuminate as a self-test. The instrument cluster will fully illuminate.

Driving Controls







Starting and Driving

Instruments and Warning Lights

Warning lights can be divided into different categories, according to the colour that they illuminate.

- RED, AMBER or YELLOW - indicates that a fault has been detected. A fault indicated by a RED light is more important than one displayed in AMBER or YELLOW.
- BLUE or GREEN - indicates that a system or feature is switched on and operating.

Warning Lights

| | |
|---|---|
|  | Tyre Pressure Monitoring System (TPMS), page 2.34 |
|  | Direction indicators, page 1.57 |
|  | Seat belt warning light, page 1.43 |
|  | Rear fog lamp, page 1.56 |
|  | Main beam headlamps, page 1.55 |
|  | Sidelamps, page 1.55 |

| | |
|---|---|
|  | Supplementary Restraint System warning light, page 1.46 |
|---|---|

| | |
|---|---|
|  | Electronic stability control, page 2.31 |
|---|---|

| | |
|---|---------------------------------|
|  | Direction indicators, page 1.57 |
|---|---------------------------------|

| | |
|---|---------------------------------|
|  | Engine warning light, page 2.13 |
|---|---------------------------------|

| | |
|---|--|
|  | Anti-lock Braking System status light, page 2.29 |
|---|--|

| | |
|---|-------------------------------|
|  | Brake warning light, page 2.9 |
|---|-------------------------------|

| | |
|---|--------------------------------|
|  | Parking brake status, page 2.8 |
|---|--------------------------------|

Main Instruments Overview

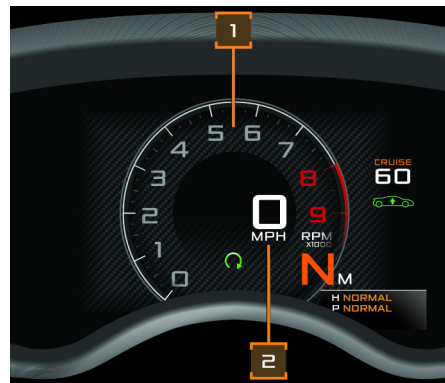

1. Tachometer, page 3.2
2. Speedometer, page 3.3

Driving Controls

Starting and Driving

Instrument Cluster - Left-hand Side

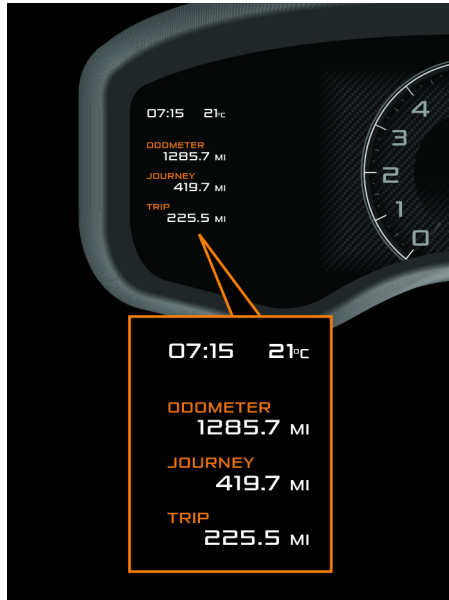

The left-hand side of the instrument cluster provides important information to the driver and will vary depending on the mode and vehicle settings selected.



Use the control stalk to navigate through the menus.

Instrument Cluster - Right-hand side

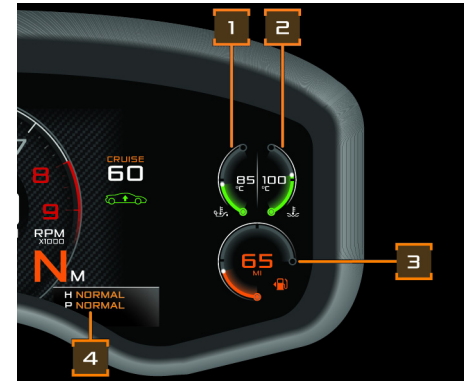

1. Oil Temperature, page 3.36
2. Water Temperature, page 3.36
3. Fuel Level and Range, page 3.37
4. Handling control, page 2.22
Powertrain control, page 2.24

Driving Controls

Starting and Driving

Seamless shift gearbox gear positions

The gearbox operates in either automatic or manual mode. Automatic mode is selected unless the driver chooses manual mode, see Manual/Automatic mode, page 2.18. If manual mode is active, gear changes are made using the gearshift paddles, see Gearshift paddles, page 2.20.

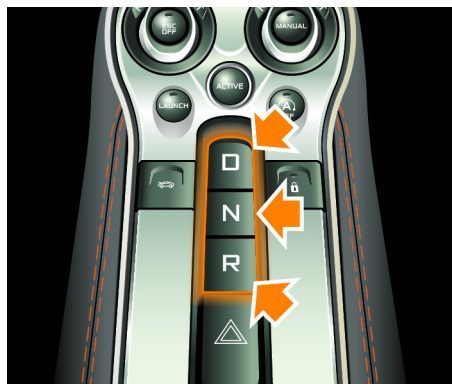

i NOTE: The letter on each button will illuminate red to identify if the vehicle is in Drive, Neutral or Reverse.

Drive

D All seven forward gears are available. Gear changes will be automatic, unless manual mode has been selected.

When drive is selected and the brakes are released, the vehicle will begin to move slowly without any throttle use making it useful for parking manoeuvres and for moving off in queuing traffic.

Neutral

N No gear is engaged. Releasing the brakes will allow the vehicle to move freely, e.g. for pushing or towing. For more information on use of neutral for towing, see Towing for recovery, page 5.44.

Reverse

R In normal circumstances, select reverse gear when the vehicle is stationary. When carrying out parking manoeuvres that require rapid changes from drive to reverse and back again, it is possible to engage reverse or drive at speeds up to 6 mph (10 kph) whilst travelling in the opposite direction.

i NOTE: If reverse or drive is selected at speeds above 6 mph (10 kph), the transmission will engage neutral, as a self protection feature.

Neutral can be selected at any vehicle speed by pressing the N button.

When reverse is selected and the brakes are released, the vehicle will begin to move slowly without any throttle use making it useful for parking manoeuvres.

Driving Controls

Starting and Driving

Gearshift paddles



To upshift, pull the right-hand paddle towards you. To downshift pull the left-hand paddle towards you. The current gear position appears on the gear position display, see Gear Position Indicator, page 3.35.

i NOTE: The single-piece paddle and central pivot enables upshifts and downshifts to be made using either paddle.

As an alternative, upshifts can be made by pushing the left-hand paddle away from you and downshifts can be made by pushing the right-hand paddle away from you.

The gearshift paddles operate irrespective of the handling and powertrain program selected, and there is no need to release the accelerator pedal to change gear.

! **WARNING:** For safety, in manual mode only, the vehicle will monitor engine speed and may perform an automatic gear change if necessary.

! **WARNING:** Do not change down for additional engine braking on a slippery surface.

i NOTE: If operating the paddles in automatic mode, the gearbox will revert to automatic changes if an eight second period elapses without a gear change being made.

To immediately shift to the lowest possible gear whilst the vehicle is moving, select and hold a downshift on the paddle. The vehicle will then go down through all gears sequentially until the optimum gear is reached or you release the paddle.

When the vehicle speed is below 6 mph (10 kph) or the vehicle is stationary with a gear selected, select a downshift and hold the paddle to select neutral.

Driving Controls

Starting and Driving

Parking brake

i NOTE: When parking on steep downhill slopes, turn the front wheels towards the kerb. When parking on steep uphill slopes, turn the front wheels away from the kerb.

Parking brake status

P If the parking brake applied status light is flashing, the parking brake has failed to engage/disengage. To resolve, engage/disengage the parking brake again. See Parking brake operation, page 2.8.

Parking brake operation



To engage the parking brake, pull the switch outwards, the red parking brake applied status light in the instrument cluster illuminates.

i NOTE: The parking brake on your vehicle is electronic and only a light application of the switch is required to engage or disengage the parking brake.



To disengage the parking brake, keep the brake pedal depressed and push the parking brake switch inwards, the red parking brake applied status light in the instrument cluster extinguishes.

! **WARNING: If the parking brake is manually released, the vehicle may start to move.**

i NOTE: If the parking brake is not manually released, it will automatically release as the vehicle is driven off forward, or in reverse as long as the following conditions are met:

Driving Controls

Starting and Driving

- driver's door is closed
- driver's seat belt is buckled

 NOTE: If the parking brake is not manually applied it will automatically apply when the engine is switched off.

 NOTE: It is only possible to disengage the parking brake with the ignition on. The parking brake can be applied in all ignition states, including vehicle asleep.

 NOTE: In the event of total footbrake failure, the parking brake can be applied when the vehicle is moving to slow the vehicle.

Brake pedal

 **WARNING: Do not keep any objects in the driver's footwell. Ensure that floor mats or carpets are properly secured and do not obstruct the pedals.**

If objects become trapped between the pedals, you may not be able to brake or accelerate, and this could lead to an accident.

 **WARNING: The braking system is servo assisted when the engine is running. The brakes will still function with the engine off, but more pressure will be required to operate them.**

 **WARNING: Do not rest your foot on the brake pedal while travelling as this may overheat the brakes, reduce their efficiency and cause excessive wear.**

 **WARNING: If the brake warning light illuminates while the vehicle is in motion, stop the vehicle as soon as safety permits and contact your McLaren retailer immediately.**

Brake discs and pads

 **WARNING: New brake pads require a period of bedding in. For the first 625 miles (1,000 km), avoid situations where heavy braking is required.**

Brake disc and pad wear depends on the driving style and driving conditions.

Brake warning light

 The brake warning light will illuminate when the ignition is switched on as a system test. If the brake warning light illuminates at any other time, a fault is indicated. Stop the vehicle as soon as safety permits and contact your McLaren retailer immediately.

Driving Controls

Starting and Driving

Starting/stopping the engine

! **WARNING:** Never run the engine when the vehicle is in an enclosed space. Exhaust fumes contain poisonous carbon monoxide. Breathing exhaust fumes could lead to unconsciousness and death.

i **NOTE:** Do not depress the accelerator pedal when starting the engine.

Starting the engine

1. Ensure that the key fob is in the vehicle.



2. Depress the brake pedal, press and release the START/STOP button and the engine will start.
3. If the START/STOP button is pressed again while the engine is cranking, cranking is stopped.

Stopping the engine

! **WARNING:** The gearbox has no Park position to lock the gears. The parking brake is the only means of preventing the vehicle moving.

i **NOTE:** Do not depress the accelerator pedal when stopping the engine.

Do not switch the engine off immediately after high speed/high load running. Allow it to run for 2 minutes so the engine temperature returns to normal.

i **NOTE:** When parking on steep downhill slopes, turn the front wheels towards the kerb. When parking on steep uphill slopes, turn the front wheels away from the kerb.

1. Pull the parking brake switch outwards to apply.

i **NOTE:** If the parking brake is not applied manually, it will apply automatically when the engine is stopped. Automatic application can be overridden by holding the parking brake switch in the off position whilst opening the driver's door.

2. Select neutral.

Driving Controls

Starting and Driving



3. Press the START/STOP button. The engine stops, the vehicle enters the Accessory state, see Vehicle electrical status, page 2.2. The immobiliser is activated.

i NOTE: If the START/STOP button is pressed for more than a second, the vehicle will enter the Awake state for a brief time before returning to Accessory state if no further inputs are made, see Vehicle electrical status, page 2.2.

Eco Start-Stop system

This system automatically stops the engine when conditions allow in order to reduce fuel consumption and exhaust gas emissions and restarts it again when required.

The following conditions must be met for the system to automatically stop the engine:

- driver is detected as present
- driving speed exceeded 6 mph (10 kph) since previous stop
- engine at normal operating temperature
- vehicle battery fully charged
- air conditioning demand not too high
- Normal Powertrain mode active

System operation



At very low speeds a status icon will be shown on the instrument cluster.

The icon will illuminate amber if conditions have not been met and the system is not available.

If all conditions have been met and the system is available, the icon will illuminate green.

The system will automatically stop the engine when the brake pedal is depressed and the vehicle has come to a complete stop.

The engine will automatically restart when the brake pedal is released.

Driving Controls

Starting and Driving

i NOTE: If the parking brake is engaged while the engine is stopped, the engine will not restart when the brake pedal is released.

Depress the brake pedal, disengage the parking brake and then release the brake pedal in order to initiate the automatic restart.

i NOTE: The engine may automatically re-start before the brake pedal is released in order to maintain electrical, air conditioning or other vehicle demand.

Deactivating



Press the Eco Start-Stop System OFF button to deactivate the system. The light in the button will illuminate and the status light in the instrument cluster will be extinguished.

Press the button again to activate the system.

i NOTE: If the deactivation button is pressed when the engine has been automatically stopped, the engine will re-start.

i NOTE: The system is active by default when the ignition is switched on, even if it has been previously deactivated.

Driving

Driving away

! **WARNING:** Never turn the engine off while driving, there will be no assistance for the steering or the foot brake. You will need more effort to steer and brake and could lose control of the vehicle and cause an accident.

i NOTE: Do not drive at high engine speeds until the engine has reached normal operating temperature.

i NOTE: The doors will lock when the vehicle reaches a speed of approximately 9 mph (15 kph). Auto lock can be set in the instrument cluster, see Auto Door Lock, page 3.23.

i NOTE: During extensive parking manoeuvring the steering assistance might feel slightly stiffer. This is normal and designed to protect the steering system from overheating.

Driving Controls

Starting and Driving

 **ENVIRONMENTAL:** When starting from cold, gear changes occur at higher engine speeds. The catalytic converter will reach its operating temperature quicker and reduce engine emissions.

1. With the engine running, press and hold the brake pedal.
2. Select drive or reverse gear, or initiate an upshift by operating the gearshift paddles. For more information, see Gearshift paddles, page 2.20 and Gear positions, page 2.17.
3. Keep the brake pedal depressed and release the parking brake switch. The red status light in the instrument cluster will be extinguished.

 **WARNING: If the parking brake is manually released, the vehicle may start to move.**

 **NOTE:** If the parking brake is not manually released, it will automatically release as the vehicle is driven off forward, or in reverse as long as the following conditions are met:

- all doors are closed
- driver's seat belt is buckled

4. Carefully depress the accelerator pedal.

Engine warning light



This engine warning light illuminates when the ignition is on and extinguishes as soon as the engine is started, provided no faults exist.

If the light illuminates while driving, an engine management fault has been detected and reduced engine performance may be experienced. Stop the vehicle as soon as safety permits and contact your McLaren retailer immediately.

Limhome mode

Limhome mode activates automatically when vehicle systems detect a fault which may cause further damage unless vehicle or system performance is restricted. Care should be taken while driving in this mode. Contact your McLaren retailer immediately.

Economical driving

Improved fuel economy can be achieved by following this advice:

- Accelerate smoothly and gently from a standing start.

- When in manual mode, avoid high engine rpm by changing to a higher gear as soon as possible.



The Gear Shift Indicator (GSI) will illuminate when an upshift would maintain optimum economy.

 **NOTE: Not available in all markets, consult your McLaren retailer.**

- Avoid labouring or over-revving the engine.
- Switch off the air conditioning when it is not needed.
- Avoid journeys where frequent stop start driving is involved.
- Ensure that your driving style suits the prevailing road and traffic conditions; allow time for smooth, progressive acceleration and braking.
- Use a reputable fuel economy tracking website to track your mileage and fuel usage.

Driving Controls

Starting and Driving

Exhaust Temperature Monitoring

The vehicle continuously monitors exhaust temperatures to protect the catalytic converters from damage caused by overheating.

If excessive exhaust temperatures are measured, a warning will be displayed on the instrument cluster.

The vehicle speed should be reduced as soon as this message is observed. Refrain from manoeuvres involving high engine speed and high engine load (full throttle) to allow the exhausts to cool. The message will remain until the temperature has reduced.

If the exhaust temperature remains at an excessive level, a second warning is displayed and limp home mode is activated. The engine performance will remain limited until the vehicle is restarted.

i NOTE: Catalytic converter over temperature warnings are not likely to be observed during normal driving and are the result of extreme operating conditions. For example, high exhaust temperatures can be caused by extended track driving, maintaining

high engine speed for long durations, and sudden and repeated changes in throttle demand.

i NOTE: High exhaust temperatures can cause damage to catalytic converters and should be avoided by practicing careful driving.

If the warnings persist, contact your McLaren retailer.

Parking Sensors



The parking sensors alert the driver to any obstructions while manoeuvring at low speeds. The system comprises four ultrasonic sensors in the front bumper, four ultrasonic sensors in the rear bumper and two sounders. Each sounder has a different pitch to indicate whether the obstruction is at the front or the rear of the vehicle.

The front parking sensors are automatically switched on when the engine is running and drive is selected. The rear parking sensors are switched on when reverse gear is

Driving Controls

Starting and Driving

selected. The light around the parking sensors button will illuminate red to indicate that parking sensors are active.

The centre sensors on the front bumper have a range of approximately 1 metre (3 feet). The centre sensors in the rear bumper have a range of approximately 1.5 metres (5 feet).

An intermittent tone is heard when an obstruction is within range. As the vehicle moves closer to an obstruction, the frequency of the tone increases. When the distance between the sensors and the obstruction is less than approximately 40 centimetres (1.5 feet), the tone becomes continuous.



WARNING: The parking sensors may not detect moving objects such as children and animals until they are dangerously close. Always manoeuvre with caution and always use your mirrors, turn your head and look behind you.



NOTE: The parking sensors are for guidance only and are not intended to replace the driver's visual checks for obstructions when manoeuvring. The parking sensors may not detect some

obstructions, such as narrow posts or small obstructions close to the ground such as kerbs.

The rear parking sensors are automatically switched off when reverse gear is de-selected. The front parking sensors are automatically switched off when the vehicle speed exceeds 16 mph (26 kph) and drive is selected. If the parking sensors have been manually activated, by pressing the centre of the button, the front parking sensors will become active again when the vehicle speed reduces to 12 mph (20 kph).

The parking sensors can be switched off manually by pressing the centre of the button, when in drive or neutral. The parking sensors cannot be manually switched off if Reverse gear is selected. When manually switched off, the light around the button will be extinguished.

When the system has been manually switched off, both the front and rear sensors will still switch on when reverse gear is selected and remain on until drive or neutral is selected again.

If a fault is detected, a long high-pitched tone will sound. If the sensors are obscured by dirt, ice or snow, clean them. If the problem persists, contact your McLaren retailer.

Driving Controls

Starting and Driving

Rear View Camera (RVC)



The Rear View Camera (RVC) is mounted in the centre of the rear bumper. The live video feed will be displayed on the instrument cluster when the function is active.

i NOTE: If the video feed is blurred or unclear, carefully clean the lens with water and a soft cloth.

A coloured grid is overlaid onto the live video feed as a guide to the proximity of visible objects to the rear bumper of the vehicle.

The red static box extends back 40 centimetres (1.5 feet) from the rear of the vehicle.

The yellow dynamic box will curve, in relation to steering angle, indicating the current path of the vehicle.

i NOTE: The rear view camera is for guidance only and is not intended to replace the driver's visual checks for obstructions when manoeuvring. The rear view camera may not show some obstructions in certain ambient light or weather conditions.

i NOTE: The steering guide grid will not be displayed if a steering angle fault exists.

The RVC is automatically activated when reverse gear is selected and automatically deactivated 10 seconds after a forward gear is selected or immediately if the vehicle's forward speed exceeds 10 mph (16 kph).



The RVC can be manually activated by selecting RVC from the instrument cluster menu using the control stalk mounted on the left of the steering column.

When the RVC has been manually activated, it can be deactivated by pushing the stalk away from you.

Driving Controls

Seamless Shift Gearbox

Overview

The gearbox is a 7-speed, dual clutch Seamless Shift Gearbox that can be operated in automatic or manual mode.

Automatic mode is selected unless the driver chooses manual mode, see Manual/Automatic mode, page 2.18.

In automatic mode, the gearbox automatically optimises the shift points to suit your style of driving by selecting the most appropriate gear depending on:

- Powertrain control, page 2.24
- Accelerator pedal position, page 2.18
- Vehicle speed
- Braking effort

i NOTE: Allow the engine and gearbox to warm up before driving at high engine speeds and high loads.

Avoid prolonged spinning of the rear wheels when driving on slippery surfaces as this could damage the drivetrain.

Gear positions



Press one of the gear position buttons.

i NOTE: The letter on each button will illuminate red to identify if the vehicle is in Drive, Neutral or Reverse.

Drive

i All seven forward gears are available. Gear changes will be automatic, unless manual mode has been selected.

When drive is selected and the brakes are released, the vehicle will begin to move slowly without any throttle use making it useful for parking manoeuvres and for moving off in queuing traffic.

Neutral

N No gear is engaged. Releasing the brakes will allow the vehicle to move freely, e.g. for pushing or towing. For more information on use of neutral for towing, see Towing for recovery, page 5.44.

Reverse

R In normal circumstances, select reverse gear when the vehicle is stationary. When carrying out parking manoeuvres that require rapid changes from drive to reverse and back again, it is possible to engage reverse or drive at speeds up to 6 mph (10 kph) whilst travelling in the opposite direction.

i NOTE: If reverse or drive is selected at speeds above 6 mph (10 kph), the transmission will engage neutral, as a self protection feature.

Neutral can be selected at any vehicle speed by pressing the N button.

Driving Controls

Seamless Shift Gearbox

When reverse is selected and the brakes are released, the vehicle will begin to move slowly without any throttle use making it useful for parking manoeuvres.

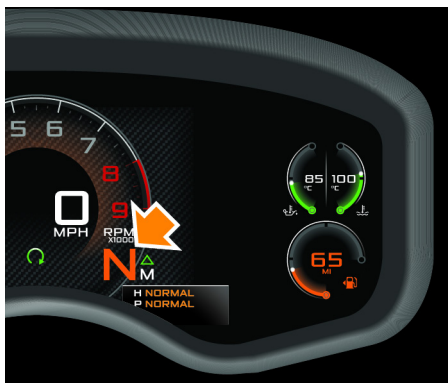

The gear (manual mode) or the gear position (automatic mode) selected will be shown in the instrument cluster.

Accelerator pedal position

Your style of driving influences how the Seamless Shift Gearbox changes gear.

With light accelerator pedal use, upshifts are made at lower engine speeds. With firmer accelerator pedal use, upshifts are made at higher engine speeds.

Kickdown

Kickdown is designed to achieve immediate acceleration when in automatic mode.

Depress the accelerator pedal fully beyond the pressure point, a click will be felt through the pedal. The gearbox will downshift immediately to the lowest appropriate gear, and maximum acceleration will follow. Once the pedal pressure is released, kickdown will cease and normal gear changes will resume.

i NOTE: Moderate accelerator pedal pressure may also cause the gearbox to downshift, depending on vehicle speed.

Manual/Automatic mode



Press the ACTIVE button (1) to switch on the active dynamics panel.

The halo around the ACTIVE button will come on. When selecting the different drive modes, their respective button will become illuminated. You can deactivate your drive mode selection at any time by pressing the ACTIVE button again. Press the MANUAL button (2) to select manual mode.

Driving Controls

Seamless Shift Gearbox

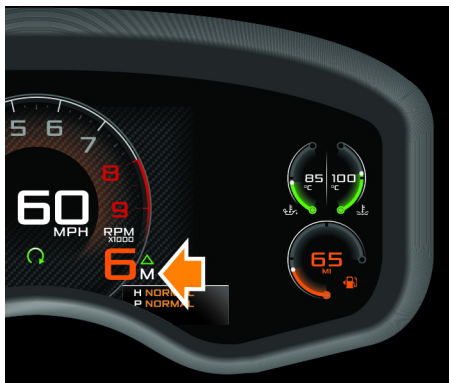

The gearbox mode indicator displays M and the currently selected gear. All forward gear changes are made by operating the gearshift paddles, see Gearshift paddles, page 2.20.

An audible shift indicator will sound to indicate that an upshift is required to maintain optimum performance.

For setting options see Performance Shift Cue (PSC), page 3.22.

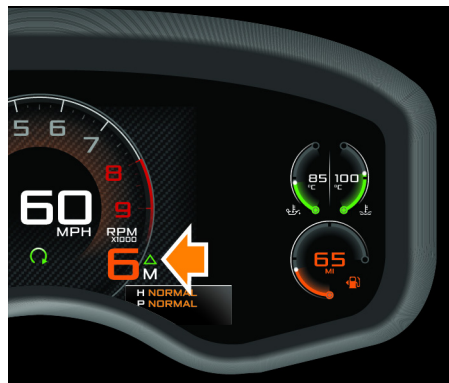

When in manual mode and driving more economically, the Gear Shift Indicator (GSI) will illuminate when an upshift would maintain optimum economy. The GSI will not illuminate if the requested acceleration or deceleration cannot be met with a higher gear. See Economical driving, page 2.13.

i NOTE: Only available in Normal powertrain and handling modes.

i NOTE: Not available in all markets, consult your McLaren retailer.

Press the MANUAL button again to revert to automatic mode.



The gearbox mode indicator displays A. All gear changes occur automatically, but if a gearshift paddle is operated the gearbox will adopt a temporary manual mode. This mode will remain active for as long as the driver continues to make manual gear changes, each within an eight second period. The gearbox mode indicator displays A/M, see Gear Position Indicator, page 3.35.

i NOTE: As soon as an eight second period has elapsed without a manual gear change being made, the gearbox will revert to automatic mode.

Driving Controls

Seamless Shift Gearbox

Gearshift paddles



To upshift, pull the right-hand paddle towards you. To downshift pull the left-hand paddle towards you. The current gear position appears on the gear position display, see Gear Position Indicator, page 3.35.

i NOTE: The single-piece paddle and central pivot enables upshifts and downshifts to be made using either paddle.

As an alternative, upshifts can be made by pushing the left-hand paddle away from you and downshifts can be made by pushing the right-hand paddle away from you.

The gearshift paddles operate irrespective of the handling and powertrain program selected, and there is no need to release the accelerator pedal to change gear.

! WARNING: For safety, in manual mode only, the vehicle will monitor engine speed and may perform an automatic gear change if necessary.

! WARNING: Do not change down for additional engine braking on a slippery surface.

i NOTE: If operating the paddles in automatic mode, the gearbox will revert to automatic changes if an eight second period elapses without a gear change being made.

To immediately shift to the lowest possible gear whilst the vehicle is moving, select and hold a downshift on the paddle. The vehicle will then go down through all gears sequentially until the optimum gear is reached or you release the paddle.

When the vehicle speed is below 6 mph (10 kph) or the vehicle is stationary with a gear selected, select a downshift and hold the paddle to select neutral.

If under 6mph (10 kph) you can also press the neutral button on the tunnel to go into neutral.

Driving Controls

Handling and Powertrain Controls

Active dynamics control

The handling and powertrain control switches, on the active dynamics panel, allow the driver to change the handling and performance characteristics of the vehicle.

The active dynamics panel contains the following controls, and will only function with the engine running or the ignition switched on.

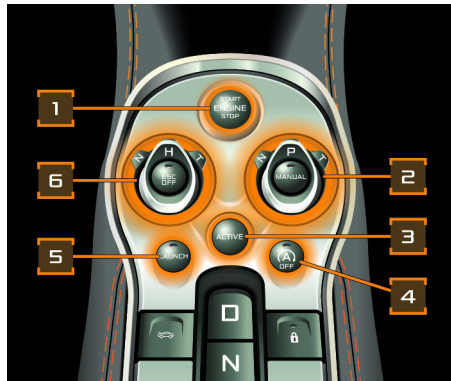

1. Engine START/STOP button, see Vehicle electrical status, page 2.2
2. Powertrain control, page 2.24 Manual/Automatic mode, page 2.18

3. Active button, page 2.21
4. Eco Start-Stop system, page 2.11
5. Launch control, page 2.26
6. Handling control, page 2.22 Electronic stability control, page 2.31

Active button



Pressing the ACTIVE button switches on the active dynamics panel. This activates the launch, handling and powertrain controls. The ACTIVE button and handling and powertrain switches will illuminate.

i NOTE: When the active dynamics panel is on, the current handling and powertrain modes will appear in orange on the instrument cluster. When the panel is off, the handling and powertrain modes will appear in white.

Driving Controls

Handling and Powertrain Controls

i NOTE: When the ignition is switched off, the controls on the active dynamics panel will also switch off. The handling and powertrain control settings will be remembered but it will be necessary to press the ACTIVE button again to operate the controls when the ignition is next switched on or the vehicle will revert to automatic gear changes.

Handling control

The handling control switch affects the following vehicle characteristics:

- Adaptive damping
- ESC settings

Selecting a setting



1. Press the ACTIVE button to switch on the active dynamics panel.



2. Rotate the handling control to select one of the following settings.

Driving Controls

Handling and Powertrain Controls

Settings

| | | |
|---|--------|--|
| N | Normal | Suspension at its softest setting, offers a compliant ride while maintaining good body control through corners. |
| S | Sport | Suspension is stiffer, giving a firmer ride coupled with enhanced handling characteristics. |
| T | Track | The suspension is at its stiffest, giving almost race car handling and ride characteristics. The electronic stability control warning light is permanently illuminated. |

i NOTE: The information displayed on the instrument cluster will change dependent on the handling mode selected. See Handling and Powertrain Display, page 3.35.

The mode selected will remain active, until the selection is changed, the ignition is switched off, or the active dynamics panel is deactivated.

i NOTE: If all the following conditions are not met when the selection is made, the mode will not be implemented until they are met:

- no fault conditions existing
- no vehicle dynamic or stability interventions activated, e.g. electronic stability control
- steering wheel in straight ahead position, and not being turned, if the vehicle is moving

When the active dynamics panel is off, the Handling display on the instrument cluster will show Normal, see Handling and Powertrain Display, page 3.35.

i NOTE: In Track handling mode, the electronic stability control system is still in operation. For further information, see Electronic stability control, page 2.31.

Driving Controls

Handling and Powertrain Controls

Powertrain control

Selecting a setting



1. Press the ACTIVE button to switch on the active dynamics panel.



2. Rotate the powertrain control to select one of the following settings.

Settings

| | | |
|---|--------|--|
| N | Normal | Gear changes are configured to offer the optimum economy without sacrificing the vehicle's inherent performance. |
| S | Sport | Gear changes will occur at a higher engine speed and with a reduced shift duration and are further enhanced with cylinder cut. See Cylinder cut, page 6.17. |
| T | Track | Gear change strategy is at its sharpest. Changes occur instantly, according to throttle response and are further enhanced with cylinder cut and inertia push. See Cylinder cut, page 6.17 and Inertia push, page 6.18. |

i NOTE: The information displayed on the instrument cluster will change dependent on the powertrain mode selected. See Handling and Powertrain Display, page 3.35.

The different gear change strategies outlined above are only relevant with automatic mode selected.

Driving Controls

Handling and Powertrain Controls

The mode selected will remain active, until the selection is changed, the ignition is switched off, or the active dynamics panel is deactivated.

When the active dynamics panel is off, the Powertrain display on the instrument cluster will show Normal, see Handling and Powertrain Display, page 3.35.

- i** NOTE: The use of the Track setting on the public road is not recommended. The Track setting is strictly intended for high performance track/off road use only.

Economy mode

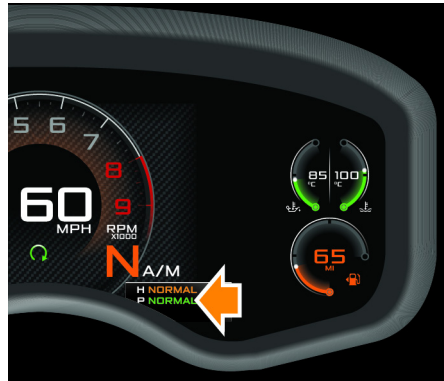

When the vehicle is operating in any powertrain setting with automatic gear shifts selected, the transmission adapts to an economical shift strategy during periods of gentle driving. This is determined by the vehicle speed, acceleration, braking and road gradient.

Depending on the current active shift strategy, the word 'NORMAL', 'SPORT' or 'TRACK' changes colour to green when economy mode is active. For information on other ways to save fuel, see Economical driving, page 2.13.

- i** NOTE: When the active dynamics panel is on, the current handling and powertrain modes will appear in orange on the instrument cluster. When the panel is off, the handling and powertrain modes will appear in white.

Driving Controls

Handling and Powertrain Controls

Launch control

Launch control is designed to offer the maximum acceleration from a standing start.

WARNING: Do not initiate launch control unless on a track. Before initiating launch control, ensure that all doors, luggage compartment and service cover are closed, and the prevailing conditions are suitable for performing maximum acceleration manoeuvres.

i NOTE: Launch control can be operated in either automatic or manual modes and any handling or powertrain mode, but only when the active dynamics panel is activated.

i NOTE: The launch sequence can be aborted at any point by carrying out any of the following actions:

- applying the parking brake
- pressing the ACTIVE button to switch off the vehicle dynamics panel
- or pressing the launch button to switch off launch control

i NOTE: If there is a fault or the launch procedure has not been followed correctly, a warning message 'Launch Mode unavailable - see owner's manual' will be shown on the instrument cluster. Repeat the launch procedure, ensuring that it is followed correctly. If the warning message remains, contact your McLaren retailer.

i NOTE: Launch mode is only available if the following conditions are met:

- both doors are closed
- vehicle ride height normal and nose lift function inactive
- atmospheric altitude has no detrimental effect with respect to engine performance
- engine coolant at normal operating temperature

Launch control process

1. Ensure the steering wheel is in a straight ahead position.
2. Depress the brake pedal firmly with your left foot and select first gear.



3. Press the ACTIVE button to switch on the active dynamics panel.

Driving Controls

Handling and Powertrain Controls



4. Press the LAUNCH button.

i NOTE: L will flash in the gearbox mode indicator, see Manual/Automatic mode, page 2.18 and 'Launch Mode active - Awaiting full throttle' will be shown on the instrument cluster.

5. With your left foot remaining on the brake pedal, press and hold the accelerator pedal down fully with your right foot, the engine speed will increase to 3,000 rpm.

i NOTE: To abort launch control release the brake pedal before pressing the accelerator pedal or wait for

approximately 100 seconds until launch control is deactivated. The message 'Launch aborted' will be shown on the instrument cluster.

i NOTE: The message 'Launch Mode active - Boost building' will be shown on the instrument cluster. Once sufficient boost has been achieved, the message 'Launch Mode active - Boost ready' will be shown on the instrument cluster.

6. Release the brake pedal with your left foot and the launch control system will perform a launch start to give maximum acceleration.

i NOTE: To abort launch control release the accelerator pedal or wait for approximately 5-10 seconds until launch control is deactivated. If the launch is aborted, release the accelerator pedal and then press again to drive away. The message 'Launch aborted' will be shown on the instrument cluster.

7. Launch control will operate if procedure has been followed correctly until aborted.

i NOTE: Whilst in launch control, the vehicle will carry out automatic gear shifts, and optimise traction. It will continue to do so until launch control is aborted. To abort launch control, release the accelerator pedal, apply the brake, or operate one of the gearshift paddles.

Driving Controls

Driving Safety Systems

General

This section contains information about the following safety systems:

- Anti-lock braking system
- Brake assist system
- Brake disc wiping
- Hill hold
- Brake-steer
- Electronic brake pre-fill
- Electronic stability control

 **WARNING: The risk of an accident increases when driving quickly, especially when cornering, on wet and icy roads. Always maintain a safe distance to the vehicle in front.**

The driving safety systems described in this section are unable to override the laws of physics.

Always adapt your driving style to suit the road and weather conditions and maintain a sufficient distance from other road users and objects on the road.

 **NOTE:** In winter conditions, the maximum effect of the anti-lock braking system, brake assist system and electronic stability control can only be achieved if you use winter tyres, with snow socks where they are necessary.

Anti-lock Braking System

The anti-lock braking system prevents the wheels from locking when you brake. This allows the vehicle to be steered during braking manoeuvres.

The anti-lock braking system works from a speed of approximately 5 mph (8 kph) upwards, regardless of road surface conditions. It works on slippery surfaces, even when you brake gently.

 **WARNING: Do not depress the brake pedal repeatedly in quick succession (pumping). Depress the brake pedal firmly and evenly. Pumping the brake pedal reduces the braking effect.**

If the anti-lock braking system operates during braking, the brake pedal pulses as this happens.

When the anti-lock braking system is activated, maintain the force on the brake pedal until the braking situation is over.

 **WARNING: Always adapt your driving style to suit the prevailing road and weather conditions and**

Driving Controls

Driving Safety Systems

maintain sufficient distance from other road users and objects on the road.

Anti-lock Braking System status light



If there is a malfunction with the system, the status light will illuminate. Do not drive your vehicle, contact your McLaren retailer as soon as possible.



WARNING: If the anti-lock braking system malfunctions, brake assist system and electronic stability control are also deactivated.

If the anti-lock braking system malfunctions, the wheels could lock when you brake. This may increase the stopping distance and impair your ability to steer.

Brake assist system

Brake assist system operates in emergency braking situations. If you depress the brake pedal quickly, the brake assist system automatically increases the force applied to the brakes and thus shortens the stopping distance.

Continue to depress the brake pedal firmly until the emergency situation is over, the anti-lock braking system prevents the wheels from locking.

When you release the brake pedal, the brakes will work as normal. Brake assist system is deactivated.



WARNING: If the brake assist system malfunctions, the brakes will still operate. However, the braking force is not automatically boosted and this may increase the stopping distance.

Brake disc wiping

Brake disc wiping operates automatically when the windscreen wipers are switched on. It prevents moisture build up on the brake discs during periods of heavy rain, improving braking performance.

Driving Controls

Driving Safety Systems

Hill hold control

If the brake pedal is applied to hold the vehicle on a hill, this function will continue to apply the brakes for 2 seconds after the pedal is released to assist a smooth start.

Brake-steer

Brake steer offers the benefits of a torque vectoring differential, but is integrated into the braking system reducing weight and providing excellent speed of response.

Torque vectoring gives the differential the ability to change the amount of power that is sent to each of the rear wheels to provide optimum stability and traction.

If the system detects that the vehicle is starting to understeer through a corner, the inside rear brake is gently applied. This helps to increase the yaw rate of the vehicle, making the vehicle feel more resistant to understeer. The lateral 'g' force is also increased giving better handling characteristics.

If the driver uses too much throttle exiting a corner, the inside rear wheel increases speed, which without brake steer could cause the vehicle to become unstable. In this situation, brake steer will again gently apply the brake on the inside rear wheel, thereby restoring traction and stability.

Electronic brake pre-fill

If the accelerator pedal is suddenly released, the electronic brake pre-fill function immediately brings the brake pads into contact with the discs, ensuring rapid braking.

Driving Controls

Driving Safety Systems

Electronic stability control

Electronic stability control (ESC) monitors driving stability and traction between the tyres and the road surface.

Electronic stability control detects when a wheel starts to spin or the vehicle starts to skid and stabilises the vehicle by braking individual wheels, and/or limiting the engine power output. This also assists when pulling away on wet or slippery road surfaces and stabilises the vehicle when braking.

 **NOTE:** Electronic stability control only functions properly if wheels with the recommended specification tyres are used.

Electronic stability control is activated automatically as soon as the engine is running.

 **WARNING:** If the electronic stability control warning illuminates, do not deactivate electronic stability control. Adapt your driving style to suit road and traffic conditions.

Traction control system

The traction control system is an integral part of electronic stability control.

The traction control system reduces engine torque to prevent the wheels from spinning. If additional intervention is required to stop the wheels from spinning, the vehicle will apply the rear brakes individually. The traction control system brakes individual drive wheels to prevent them from spinning. This means that the vehicle can accelerate on slippery surfaces.

 **WARNING:** The traction control system cannot reduce the risk of an accident if you drive too fast. The traction control system is unable to override the laws of physics.

Deactivating Electronic Stability Control

 **WARNING:** When electronic stability control is deactivated, the risk of the vehicle skidding is increased. Adapt your driving style to suit road and traffic conditions.

 **WARNING:** Do not deactivate electronic stability control unless on a track and prevailing conditions are suitable.

 **NOTE:** When you deactivate electronic stability control, the following conditions result:

- the 'ESC OFF' warning light illuminates
- the light on the ESC OFF button illuminates
- electronic stability control no longer improves driving stability
- the engine's torque is no longer limited and the drive wheels could spin
- the anti-lock braking system remains activated

Driving Controls

Driving Safety Systems

Dynamic ESC modes

The level of electronic stability control can be adjusted to various dynamic modes to suit the driver's requirements and is dependent on the handling mode currently active.

Electronic stability control dynamic modes can be selected at any vehicle speed.

Ensure Sport or Track handling mode is active, see Handling control, page 2.22.



Sport dynamic mode

1. Select Sport handling mode.
The electronic stability control is **ON** by default.
2. Press the **ESC OFF** button briefly to activate **Sport Dynamic** mode which allows more dynamic freedom over the default **ESC ON** mode.
ESC DYN will be displayed on the instrument cluster.

Track dynamic mode

1. Select Track handling mode.
The electronic stability control is **ON** by default.
2. Press the **ESC OFF** button briefly to activate **Track Dynamic** mode which allows a further increase in dynamic freedom over **Sport Dynamic** mode.
ESC DYN will be displayed on the instrument cluster.

ESC Off

1. Select Sport or Track handling mode.
2. If not already in a dynamic ESC mode, press the **ESC OFF** button briefly to activate a dynamic ESC mode.

3. Press and hold the **ESC OFF** button for 2 seconds, followed by a confirmation press again within 5 seconds to deactivate the electronic stability control.
ESC OFF will be displayed on the instrument cluster and the light on the **ESC OFF** button will illuminate.

Driving Controls

Driving Safety Systems

Reactivating Electronic Stability Control

When electronic stability control is reactivated, the electronic stability control OFF warning light in the instrument cluster extinguishes.

i NOTE: Electronic stability control is automatically reactivated when the ignition is next switched off and on again.

- Press the ESC OFF button briefly, the light on the button will be extinguished.
- Change the setting on the handling control to Normal.
- Switch the ignition off and then switch on again.

Reactivation Procedure



Perform any of the following to reactivate electronic stability control:

Driving Controls

Driving Safety Systems

Tyre Pressure Monitoring System (TPMS)

Prior to every time the vehicle is to driven, each tyre should be checked when cold and inflated/deflated to the inflation pressure recommended by the vehicle manufacturer on the vehicle placard or tyre inflation pressure label. (If your vehicle has tyres of a different size than the size indicated on the vehicle placard or tyre inflation pressure label, you should determine the proper inflation pressure for those tyres).

In certain circumstances it is possible that the Tyre Pressure Monitoring System (TPMS) pressure warning will display without the loss of air from the tyre. This may be due to temperature variations between the locations where the tyre pressure was set and where the vehicle is driven. For example setting pressures in an air conditioned or heated garage and then driving the vehicle outside may induce a tyre pressure warning after a short period of driving. The warning may also display when extreme ambient temperature variations occur or during seasonal temperature changes.

 **WARNING: Never ignore a tyre pressure warning. Check tyre pressures immediately and if necessary contact your McLaren retailer.**

Tyre Pressure Monitoring System overview



The Tyre Pressure Monitoring System warns you when the pressure drops or the temperature increases above an acceptable level in one or more of the tyres.

The system monitors the tyre pressures and temperatures in each wheel using sensors located in each tyre valve and a receiver

located within the vehicle. Communication between the sensors and the receiver is via Radio Frequency (RF) signals.

 **NOTE:** The Tyre Pressure Monitoring System can suffer interference if you are operating radio transmitting equipment (e.g. radio headphones, two-way radios) in or near the vehicle.

 **NOTE:** The Tyre Pressure Monitoring System will begin transmitting once the vehicle is travelling over 6 mph (10 kph), there will be a delay of up to 2 minutes before this information is displayed on the instrument cluster.

Tyre Pressure Monitoring System operation

 If a low tyre pressure is detected, the Tyre Pressure Monitoring System warning light will illuminate along with an associated error message on the instrument cluster.

Stop the vehicle as soon as possible, check all your tyres and inflate them to the recommended pressure, see Tyre pressures, page 5.35. The warning light will be extinguished once the tyres have been inflated to the correct pressure.

Driving Controls

Driving Safety Systems

Driving on a significantly under-inflated tyre causes the tyre to overheat and can lead to tyre failure. Under-inflation also reduces fuel efficiency and tyre tread life, and may affect the vehicle's handling and stopping ability.

⚠ WARNING: TPMS is not a substitute for proper tyre maintenance, and it is the driver's responsibility to maintain correct tyre pressure, even if under-inflation has not reached the level to trigger illumination of the TPMS low tyre pressure warning light.

Each tyre should be checked weekly when cold and inflated/deflated to the inflation pressure recommended on the tyre inflation pressure label.

Navigate through the 'Vehicle Info' screen on the instrument cluster to view the current tyre pressures, see Vehicle Info, page 3.9.

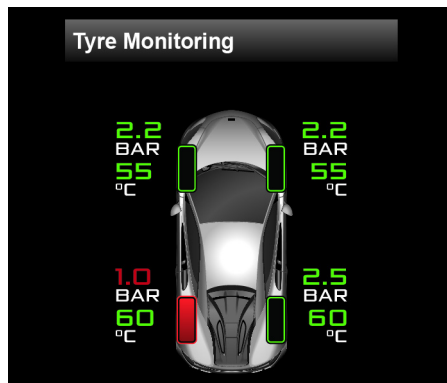

The display shows the pressures of each of the four tyres. If the pressure figure appears in green, no action is required. If it appears as red text, inflate the associated tyre to the correct pressure as soon as possible.

Inspect the tyre(s) for any possible causes of reduced tyre pressure.

⚠ WARNING: The tyre pressures indicated on the instrument cluster will be more accurate with a pressure gauge. The Tyre Pressure Monitoring System is not a substitute for manually checking tyre pressures or checking for wear and damage. The system only

provides a low tyre pressure warning and does not re-inflate the tyres.

The Tyre Pressure Monitoring System cannot alert you to damage to a tyre. Regularly check the condition of your tyres.

⚠ WARNING: If low pressure warnings occur frequently, have the tyres checked at your McLaren retailer. Driving on an under-inflated tyre will cause the tyre to overheat and can lead to tyre failure.

- 🌿 ENVIRONMENTAL:** Under-inflated tyres reduce fuel efficiency and tyre tread life, and may affect the vehicle's handling and braking characteristics.
- 🌿 ENVIRONMENTAL:** Check tyre pressures at least every 7 days.

Tyre Temperature Monitoring System operation

If a high tyre temperature is detected, the Tyre Temperature Monitoring System will display an error message on the instrument cluster.

Driving Controls

Driving Safety Systems

Navigate through the 'Vehicle Info' screen on the instrument cluster to view the current tyre temperatures, see Vehicle Info, page 3.9.

Inspect the tyre(s) for any possible causes of increased tyre temperature.

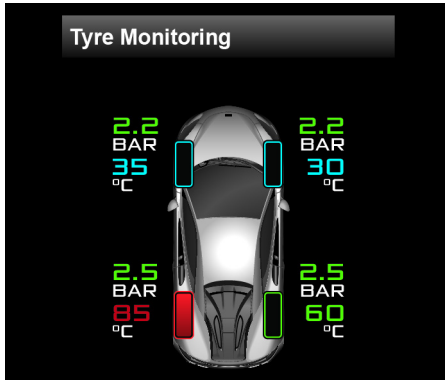

This shows the current temperature of each of the four tyres. If the temperature appears in blue, the tyres have not yet warmed up to optimum operating temperature. If the temperature appears in green, no action is required. If it appears in red, the safe operating temperature of the tyres has been exceeded. Reduce speed or stop the vehicle until the temperatures are at a safe level, i.e. temperatures are displayed in green.

Driving Controls

Cruise Control

Overview

WARNING: Pay particular attention to road and traffic conditions, when cruise control is activated, and always travel at a speed which is safe for the current conditions.

Never use cruise control on winding or slippery roads or when visibility is poor, e.g. in fog, heavy rain or snow.

Cruise control allows the driver to maintain a constant speed without using the accelerator pedal. This is useful on motorway journeys where a constant speed can be maintained for long periods.



All cruise control functions are operated by the cruise control stalk, positioned on the right of the steering column.

Using cruise control

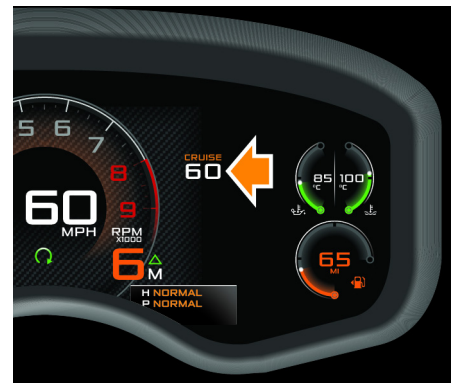

Accelerate to the desired speed and push the stalk up briefly, to activate cruise control. The set speed will appear on the instrument cluster.

i NOTE: Cruise control will only operate at speeds in excess of 20 mph (30 kph).

Speed can be increased at any time by pressing the accelerator pedal. Once the accelerator pedal is released the vehicle will return to the cruise speed.

Driving Controls

Cruise Control

 **WARNING:** Always be aware that cruise is engaged and do not override cruise for extended periods. Releasing the accelerator in these circumstances could lead to the vehicle not decelerating at the rate you expect.

Canceling cruise control

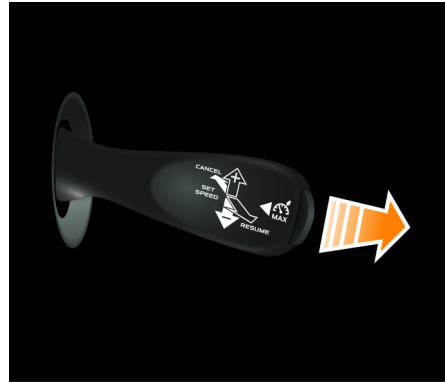

Briefly press the cruise control stalk away from you.

Cruise control is cancelled. The indicator in the instrument cluster extinguishes but the last speed set remains stored.

 **NOTE:** The last speed stored is cleared when you switch off the engine.

Cruise control is also cancelled if the foot brake is pressed, if neutral is selected or if Active Speed Limiter is selected.

 **NOTE:** Cruise control is cancelled automatically if electronic stability control detects wheel spin or vehicle skid or if electronic stability control is switched off.

Driving Controls

Cruise Control

Increasing cruise speed



- A brief press of the stalk upwards will increase the vehicle speed in 1 mph (1 kph) increments (depending on the units selected, see Units, page 3.16);
- or press and hold the stalk upwards until the desired speed is reached, then release the stalk;
- or accelerate to the new desired speed and push the stalk up.

Reducing cruise speed



- A brief press of the stalk downwards will decrease the vehicle speed in 1 mph (1 kph) decrements (depending on the units selected, see Units, page 3.16);
- or press and hold the stalk downwards, the vehicle will decelerate, release the stalk when the desired speed has been reached.

i NOTE: If you decelerate using the cruise control stalk, the gearbox may shift down to increase the rate of deceleration.

Downshifting manually using the gear change paddles will not disengage cruise control.

Driving Controls

Cruise Control

Resuming a stored speed

 **WARNING:** Only resume the stored speed if it is appropriate for the current road and traffic conditions. Sudden acceleration could endanger yourself and others.



Pull the cruise control stalk briefly towards you.

Cruise control will adjust the vehicle's speed to the last speed stored.

Driving Controls

Active Speed Limiter (ASL)

Setting an upper speed limit

- WARNING:** It is the driver's responsibility to keep within proper speed limits.
- WARNING:** The ASL feature may allow the vehicle to exceed the upper speed limit in certain situations, for example when descending steep gradients.
- NOTE:** ASL can be activated when the vehicle is stationary. The upper speed limit will be set to a default speed of 20 mph (30 kph).

The ASL control allows the driver to set an upper speed limit.

Selecting a speed

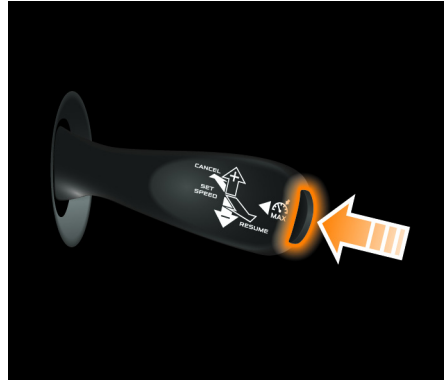

1. Press the button on the end of the cruise control stalk, to select ASL mode.
2. Accelerate or decelerate the vehicle to the maximum permitted speed.
3. Push the stalk up briefly to select the desired ASL upper speed limit.

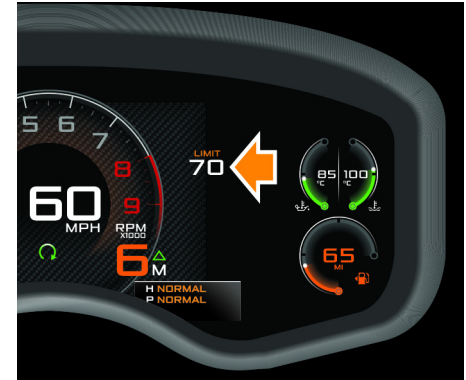

4. The upper speed limit appears on the instrument cluster.
- NOTE:** The ASL can be overridden by depressing the throttle pedal beyond a predetermined point.

Driving Controls

Running In

Running in

Observe the following running in instructions when the vehicle is new or if any of these components have been replaced.

Engine and gearbox

For the first 625 miles (1,000 km):

- drive at varying road and engine speeds
- do not drive faster than the maximum speed limit of the road, or 150 mph (240 kph)
- do not use your vehicle on a race track
- avoid heavy loads on the engine (driving at full throttle)
- avoid driving at engine speeds less than 2,000 rpm
- avoid running at constant speed and load for long periods
- avoid using kickdown
- do not downshift for additional engine braking
- avoid stopping the engine within 2 minutes of high speed and high load running

- avoid idling the engine for more than 10 minutes

After the 625 miles (1,000 km) running in period, you may gradually use the vehicle's full performance.

 **NOTE:** Failure to observe the engine and gearbox operating limits during the running in period may lead to premature wear or damage.

 **NOTE:** These running in instructions also apply for the first 625 miles (1,000 km) after the engine or transmission has been replaced.

 **ENVIRONMENTAL:** This advice will assist in improving fuel economy and should be adopted as normal driving practice even after the running in period.

Brakes

New brakes require an initial bedding in period. Avoid heavy braking situations for the first 625 miles (1,000 km).

Normal/Road use

- Allow the engine to warm up before driving at high engine speeds and high loads. Limit engine speed to 5,000 rpm until the engine reaches full operating temperature.
- Avoid stopping the engine within 2 minutes of high speed/high load running.
- Avoid idling the engine for more than 10 minutes.

Driving Controls

Running In

Track use

 NOTE: Do not use the vehicle on a track during the running in period.

Before you use your vehicle on the track, consult your McLaren retailer. McLaren recommend that your vehicle is inspected before and after track use.

Driving Controls

Refuelling

Filling with fuel

 **WARNING: Fuel is highly flammable.** Fire, naked flames, smoking and using a mobile telephone are prohibited when handling fuels. Switch off the engine before refuelling.

 **WARNING: Fuel and fuel vapours can damage your health. Do not inhale fuel vapours or allow fuel to come into contact with skin or clothing.**

The fuel filler flap is located at the rear on the left-hand side. It is locked or unlocked automatically when the vehicle is locked or unlocked.

 **NOTE:** Do not attempt to force the filler flap open if the vehicle is locked. You may damage the flap and its locking mechanism.

 **NOTE:** The fuel filler flap will remain locked if the engine is running.

Filling on the forecourt

1. Switch off the engine.



2. Press the rear edge of the fuel filler flap, the latch will release.

3. Open the flap.

 **NOTE:** Your vehicle is not fitted with a fuel filler cap.

4. Insert the nozzle into the fuel filler and dispense fuel. For fuel recommendations, see Recommended fuel, page 2.46.

5. Do not continue to fill the tank after the pump nozzle switches off.

6. Remove the nozzle.

7. Close the fuel filler flap, you will hear the latch engage.

Driving Controls

Refuelling

Filling with the fuel funnel

i NOTE: The fuel funnel should only be used when filling the fuel tank from sources other than a forecourt fuel pump.

1. Switch off the engine.



2. Press the rear edge of the fuel filler flap, the latch will release.
3. Open the flap.

i NOTE: Your vehicle is not fitted with a fuel filler cap.



4. Collect the fuel funnel from the luggage compartment, see Fuel funnel, page 5.13.
5. Insert the fuel funnel fully into the filler neck.
6. Insert the nozzle into the fuel funnel and dispense fuel. For fuel recommendations, see Recommended fuel, page 2.46.
7. Do not overfill.

! **WARNING: Take care to avoid spillages and overfilling. Ensure any spillages are cleaned immediately.**

8. Remove the nozzle.

9. Remove the fuel funnel, clean thoroughly and store in the luggage compartment.
10. Close the fuel filler flap, you will hear the latch engage.

Driving Controls

Refuelling

Recommended fuel

For maximum engine performance the use of 98 RON/88 MON unleaded petrol meeting specification EN 228 is required.

In areas where 98 RON/88 MON is unavailable, use unleaded premium grade petrol with a minimum octane rating of 95 RON/85 MON, meeting specification EN 228.



NOTE: Information relating to the quality of fuel being dispensed is displayed on the filling pump.



NOTE: The likelihood of engine wear or damage is increased if fuel does not meet the requirements of EN 228 for unleaded petrol or if fuel additives are used.

Damage caused by use of incorrect fuel is not covered by the vehicle warranty.



NOTE: This vehicle is not suitable for use with fuels containing more than 10% Ethanol.

Do not use E85 fuels (85% Ethanol content). This vehicle is not fitted with the equipment necessary for the use

of fuels containing more than 10% Ethanol. If E85 fuels are used, serious damage will occur to the engine and fuel system.

Driving Controls

Winter Driving

Winter driving

It is recommended that you have your vehicle inspected at your McLaren retailer at the onset of winter. This service includes the following:

- checking the antifreeze/anti-corrosion concentration
- adding concentrated cleaning agent to the windscreen cleaning system
- checking the battery
- changing the tyres

Winter tyres

Use winter tyres below 7°C (45°F) and on snow or ice-covered roads. The maximum effect of the anti-lock braking system and electronic stability control systems is only achieved with these tyres.

Use winter tyres of the same make and tread on all wheels to maintain safe handling characteristics. Change the tyre type in 'Vehicle Settings' on the instrument cluster, see Tyre Type, page 3.25.

Winter tyres are directional, not asymmetrical, and so must be fitted in accordance with the directional markings on the sides of the tyres.

 NOTE: Only winter tyres specified by McLaren should be used.

 **WARNING: Replace winter tyres with a tread depth of less than 4 mm immediately. They are not suitable for winter use because they do not provide sufficient grip, and could cause an accident.**

 NOTE: A wheel change must be carried out at your McLaren retailer. The vehicle could be damaged if it is jacked up incorrectly.

Consult your McLaren retailer for advice and information regarding the maximum speed specified for the winter tyres fitted. Restrict the maximum speed of the vehicle using the ASL system, see Setting an upper speed limit, page 2.41.

Snow socks

McLaren recommends that you only use snow socks which have been approved for McLaren vehicles. If you are intending to fit snow socks, bear the following points in mind:

- Only ever fit snow socks to both rear wheels.
- Comply with the manufacturer's installation instructions.

Do not exceed the maximum permissible speed of 30 mph (50 kph). Remove the snow socks as soon as possible if you are no longer driving on snow-covered roads.

McLaren

Instruments

| | |
|---|------------|
| Overview..... | 3.2 |
| Overview | 3.2 |
| Tachometer | 3.2 |
| Speedometer | 3.3 |
| Instrument Cluster Display..... | 3.4 |
| Overview | 3.4 |
| Home Screen..... | 3.7 |
| Trip Computer..... | 3.8 |
| Vehicle Info..... | 3.9 |
| Nose Lift..... | 3.12 |
| Settings..... | 3.16 |
| Navigation | 3.27 |
| Messages - Coupe, GT and Spider | 3.28 |
| Messages - Spider Only..... | 3.30 |
| Display Window..... | 3.32 |
| Gear Position Indicator..... | 3.35 |
| Handling and Powertrain Display | 3.35 |
| Electronic Stability Control Mode Display | 3.35 |
| Oil Temperature..... | 3.36 |
| Water Temperature | 3.36 |
| Fuel Level and Range | 3.37 |

Instruments

Overview

Overview

The instruments are activated when the ignition is switched on, see Switching on the ignition, page 2.3.

WARNING: No messages will appear in the instrument screen if there is a fault with the screen or vehicle electrics. Contact your McLaren retailer immediately. Use of the vehicle in these circumstances can be dangerous.

Tachometer

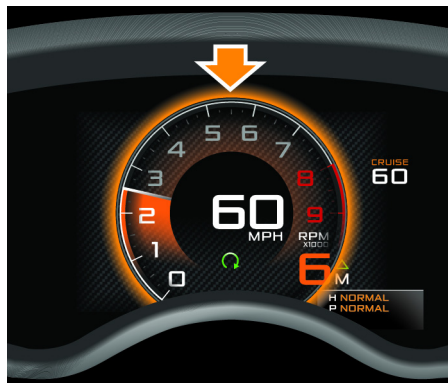

The tachometer display appears in the centre of the instrument cluster when in Normal Powertrain and Handling modes. The red number on the display indicates the engine's maximum RPM.

When Sport or Track Powertrain or Handling modes are selected, the tachometer style will change to suite the selected mode. See Display Window, page 3.32.

NOTE: The maximum RPM is dynamic and will be reduced under certain conditions, for example, if the engine

oil is below normal operating temperature or if neutral gear is selected.

NOTE: Do not operate the engine at or near its maximum speed for a significant length of time. The fuel supply is cut off to protect the engine when the maximum RPM is reached.

Shift lights

When Track Powertrain or Handling mode is selected, shift light will be displayed. The shift lights are arranged in three groups of four LEDs; a green group, red group and blue group. Each group illuminates as engine RPM increases. Accelerating the engine speed beyond the point that the blue group is illuminated is not conducive to rapid acceleration.

Instruments

Overview

Speedometer



The speedometer is a digital display situated centrally within the instrument cluster when in Normal Powertrain and Handling modes.

When Sport or Track Powertrain or Handling modes are selected, the speedometer style will change to suite the selected mode. See Display Window, page 3.32.

i NOTE: The speedometer changes from mph to kph when the units are changed from miles to kilometres, see Units, page 3.16.

Instruments

Instrument Cluster Display

Overview

Warnings appear in a pop-up window on the instrument screen.

The stored messages can be viewed at any time when the ignition is on, see Error Messages, page 3.9.

 **WARNING: Operating and browsing menus whilst the vehicle is in motion could make you unable to observe road and traffic conditions and could cause an accident.**

 **WARNING: Do not ignore warning messages, failure to take appropriate action may result in personal injury or damage to the vehicle.**



Navigation through the menu structure is achieved using the control stalk mounted on the left of the steering column.

Depending on the specific model of your McLaren, the following categories are available:

See Home Screen, page 3.7

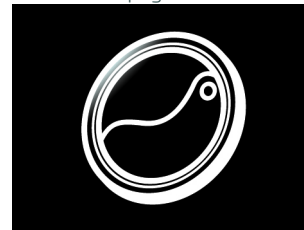

See Trip Computer, page 3.8

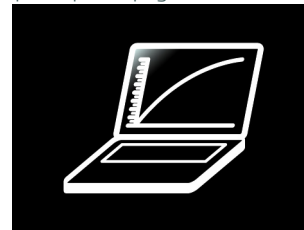

See Vehicle Info, page 3.9



Instruments

Instrument Cluster Display

See Nose Lift, page 3.12

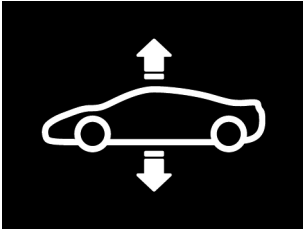

See Settings, page 3.16

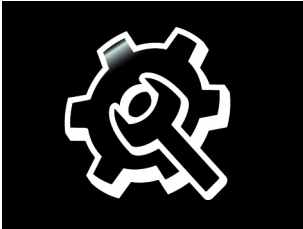

See Navigation, page 3.27



See Rear View Camera (RVC), page 2.16

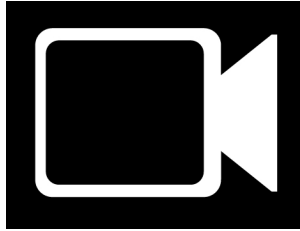

Navigate through a category

1. Move the control stalk up or down (SCROLL + or -) to highlight your choice.
2. Pull the stalk towards you (FORWARD) to enter your selection.
3. Then select the topic of interest from the list, move the control stalk up or down (SCROLL + or -) to highlight your choice.
4. Pull the stalk towards you (FORWARD) to move through to the next menu in the structure.
5. At the end of each structure there will be a display of information or a screen where a setting can be changed.

Instruments

Instrument Cluster Display

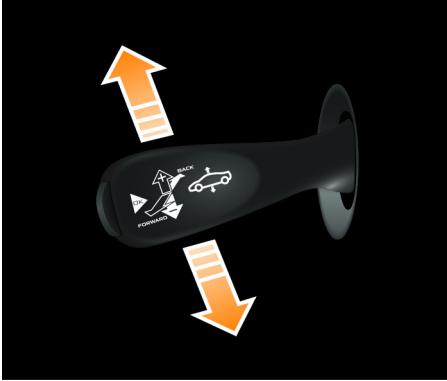

6. When the function required is selected or a setting is made, press OK on the end of the control stalk to confirm. A setting is only changed if the OK button is pressed.

Instruments

Instrument Cluster Display

Home Screen

To change the content and layout of the Home screen, see Language, page 3.17.



The Home screen displays the following functions:

Clock

The clock displays the current time. For more details refer to Restore Default Settings, page 3.26.

Temperature

 **WARNING: Even if the temperature displayed is above freezing point, the road surface may still be icy. You should always adapt your driving style and speed to suit the weather conditions.**

Temperature is the current outside temperature. There is a short delay before a change in outside temperature is displayed.

When the outside air temperature falls below 3°C (37°F), the frost warning message will be displayed and the temperature reading will change colour after the message has been displayed.

When the outside temperature falls below 0°C (32°F), the ice warning will be displayed.

Odometer

The odometer displays the total distance the vehicle has travelled.

Journey trip

This displays the distance travelled during the current journey. Refer to Trip Computer, page 3.8 for more details.

Trip

This displays the distance travelled since the trip meter was last reset. Refer to Trip Computer, page 3.8 for more details.

Instruments

Instrument Cluster Display

Trip Computer

The trip computer can generate Trip or Journey Trip information.

Trip

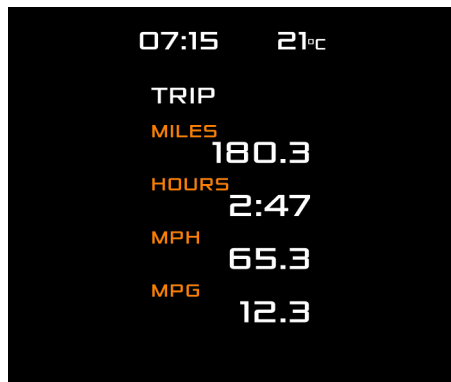

Displays distance, average speed and average fuel consumption since the last trip reset.

The hours displayed is the time that the engine has been running since the last trip reset.

Press the OK button on the end of the control stalk for 2 seconds to reset the information back to zero.

Journey Trip

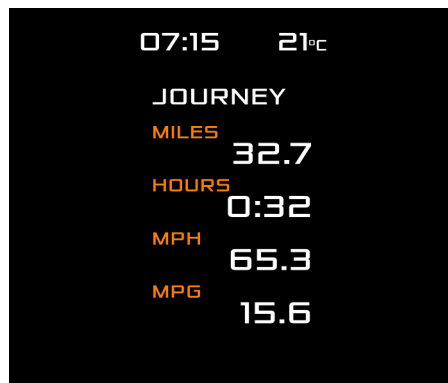

Displays distance, average speed and average fuel consumption for the current journey.

The hours displayed is the time the engine has been running in the current journey.

Press the OK button on the end of the control stalk for 2 seconds to reset the information back to zero.

The information will also reset to zero when the engine is switched off for approximately 2 hours.

Instruments

Instrument Cluster Display

Vehicle Info

Overview

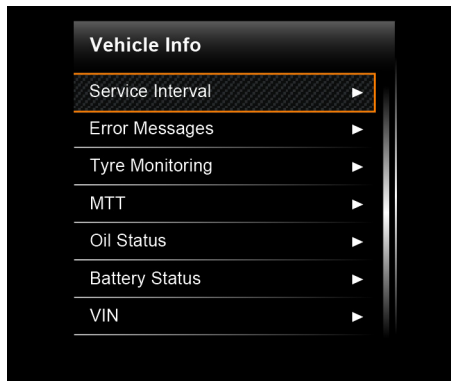

The following choices can be made from the Vehicle info screen.

- Service Interval, page 3.9
- Error Messages, page 3.9
- Tyre Monitoring, page 3.10
- Oil Status, page 3.10
- Battery Status, page 3.10
- Vehicle Identification, page 3.11

Service Interval

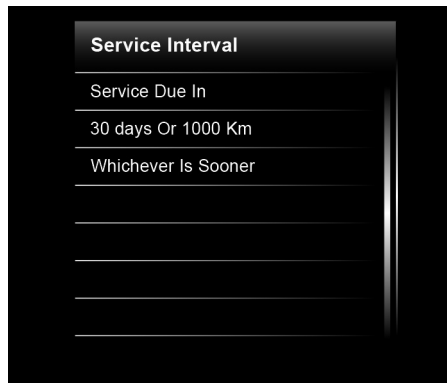

At approximately 30 days or 625 miles (1,000 km) before a service is due, the above display appears.

The message will then appear every time the ignition is switched on, with the time/distance figures reducing. Once the service has been carried out, the display will be reset by your McLaren retailer.

If a service becomes overdue, the display will show the distance it is overdue.

Error Messages

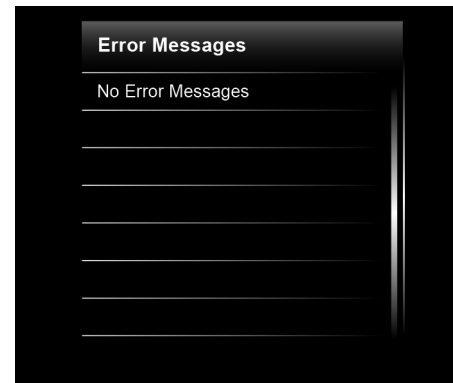

If no error messages have been logged, the display will confirm this.

If any errors have been logged, the screen will display error messages with arrows to scroll through the messages.

Instruments

Instrument Cluster Display

Tyre Monitoring

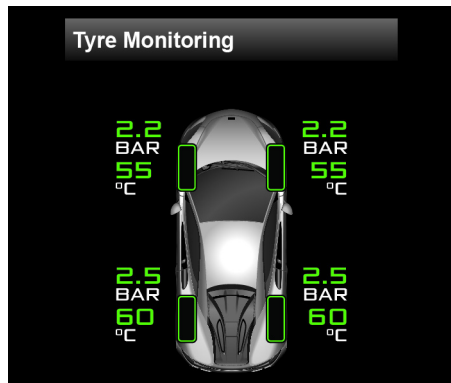

This shows the pressures and temperatures of each of the 4 tyres. If the figures and tyres appear in green, no action is required. If they appear as amber or red text, have the tyres inspected and pressures rectified as soon as possible.

Inspect the tyre(s) for any possible causes of reduced pressure or increased temperature.

Oil Status

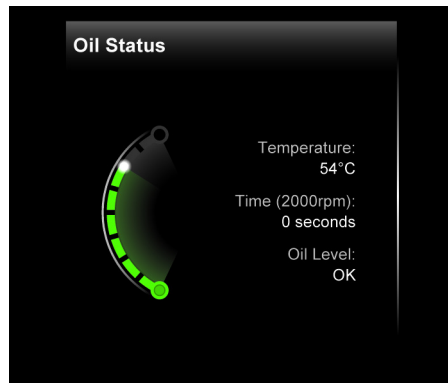

Displays a gauge showing the level of oil, together with the oil temperature.

To check the engine oil level, see [Checking the engine oil](#), page 5.2.

Battery Status

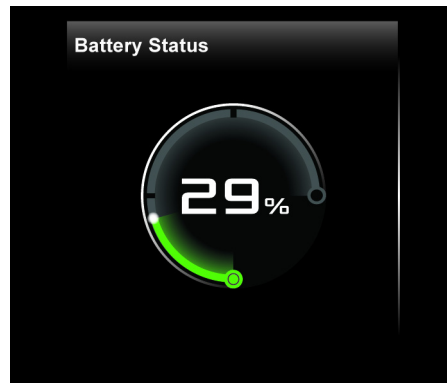

Displays a gauge showing the battery charge status.

To charge the battery, see [Charging the battery](#), page 5.14.

To see how long the vehicle can be parked without the engine running or charging the battery, see [Parking days](#), page 2.3.

Instruments

Instrument Cluster Display

Vehicle Identification

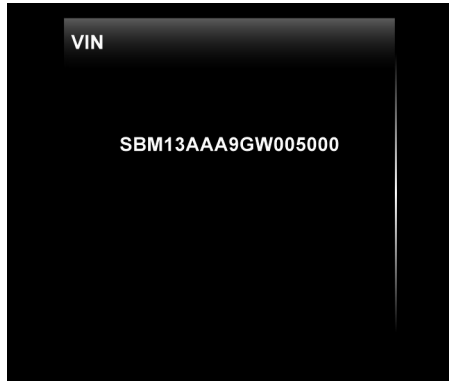

Displays the vehicle identification number.

Instruments

Instrument Cluster Display

Nose Lift

i NOTE: If the nose lift icon on the instrument cluster is amber, or a vehicle lift fault message appears on the instrument cluster, the system is not available. Do not drive the vehicle at high speed and contact your McLaren retailer as soon as possible.

The nose lift menu displays the following information:

- Nose Lift - Raise, page 3.13
- Nose Lift - Lower, page 3.14

A confirmation tone will be heard when nose lift is selected.

Nose lift gives you the option to raise or lower the nose of the vehicle dependent on the current nose ride height.

Nose ride height can only be raised when travelling at speeds below 31 mph (50 kph). The nose will automatically lower at speeds above 37 mph (60 kph).

i NOTE: The front suspension can be left fully raised for extended periods, but it may relax to a lower level over time.

If the nose is left in a raised position for a long period, a system reset may occur when the engine is next started to return the nose to normal ride height.

If nose lift is used when in motion, slight adjustments to the steering feel may be experienced, this is normal and does not affect the operation of the vehicle.

- i** NOTE: Vehicle handling modes are inhibited when nose lift is lowering or raising.
- i** NOTE: Nose lift will be unavailable if launch mode is active.
- i** NOTE: If nose lift is requested while the engine has been stopped by the Eco Start-Stop System, the engine will be automatically restarted.

Accessing the Menu

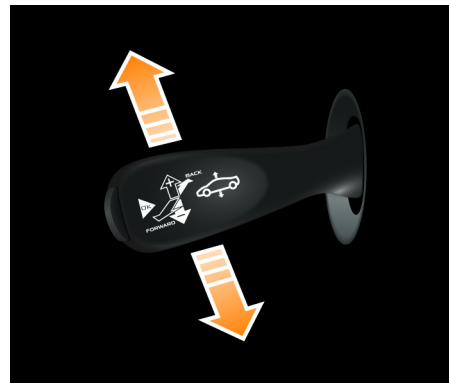

You can access the nose lift menu using the menu control stalk on the left of the steering column, whenever the engine is running.

- i** NOTE: Vehicle handling modes are inhibited when vehicle lift is lowering or raising.
- i** NOTE: Nose lift will be unavailable if launch mode is active.

Hold the menu control stalk up for one second to quickly access the menu. A confirmation tone will be heard.

Instruments

Instrument Cluster Display

The nose lift display will exit after the timeout duration has been exceeded back to home screen if there is no activity on the menu. To set the timeout to home screen duration, see Language, page 3.17.

Nose Lift - Raise

- i** NOTE: When the vehicle is at normal ride height, you will only have the option to raise the front of the vehicle.
- i** NOTE: Nose lift will be delayed if the vehicle experiences any excessive steering wheel input.
- i** NOTE: Always check the nose lift icon on the display before driving your vehicle.



Before nose lift will become active, the engine must be running. To raise the nose of the vehicle, select the nose lift menu (see Accessing the Menu, page 3.12) and then move the menu control stalk upwards.

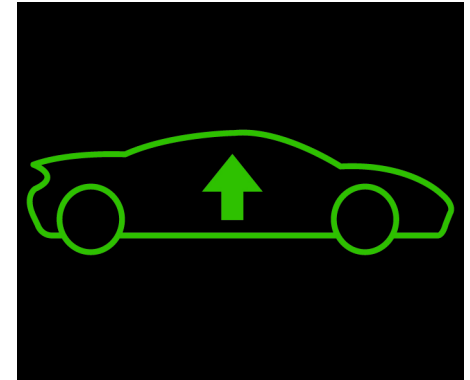

The change in nose ride height is confirmed by an ascending audible tone. 'Vehicle raising' appears on the instrument cluster and the nose lift icon will flash.

If the engine is stopped while the vehicle is raising, the system will stop and continue to raise only when the engine is restarted.

To change from raise to lower, move the menu control stalk downwards. The nose of the vehicle will start to lower, and the information displayed on the instrument cluster will confirm the change.

Instruments

Instrument Cluster Display

When the nose is fully raised, an audible confirmation tone is heard. 'Ride height raised' appears on the instrument cluster and the nose lift icon is illuminated while the vehicle remains raised.

If there is no further activity, the vehicle raise text display will exit after the timeout duration has been exceeded. To set the timeout to home screen duration, see Language, page 3.17.

Nose Lift - Lower

- i** NOTE: To lower the front of vehicle while stationary, the engine must be running and the driver's door must be fully closed.
- i** NOTE: When the nose is raised, you will only have the option to lower the nose.
- i** NOTE: Do not drive at high speed whilst the nose is lowering. If the nose begins to auto lower, a descending audible tone is heard, and the nose lift menu will be displayed on the instrument cluster allowing you control of the system.
- i** NOTE: Always check the nose lift icon on the instrument cluster before driving your vehicle.



To lower the nose of the vehicle, select the nose lift menu (see Accessing the Menu, page 3.12) and then move the menu control stalk downwards.

The change in nose ride height is confirmed by a descending audible tone. 'Vehicle lowering' appears in the instrument cluster and the screen nose lift icon will flash.

Instruments

Instrument Cluster Display

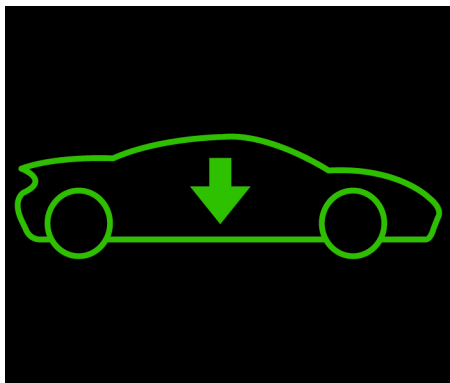

To change from lower to raise, move the menu control stalk upwards. The nose will start to raise, and the information displayed on the instrument cluster will confirm the change.

When the nose is lowered, an audible confirmation tone is heard. 'Ride height normal' appears on the instrument cluster and the nose lift icon extinguishes.

If there is no further activity, the vehicle lower text display will exit after the timeout duration has been exceeded. To set the timeout to home screen duration, see Language, page 3.17.

Instruments

Instrument Cluster Display

Settings

Overview

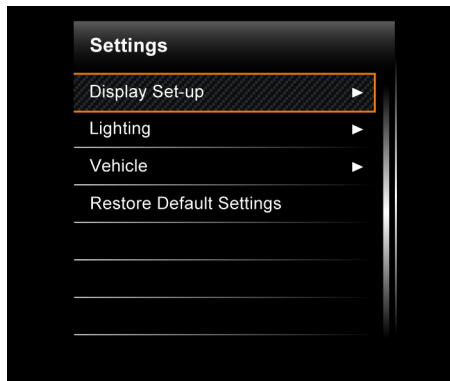

The following choices can be made from the Settings screen:

- Display Set-up, page 3.16
- Lighting, page 3.18
- Vehicle, page 3.19
- Restore Default Settings, page 3.26

Display Set-up

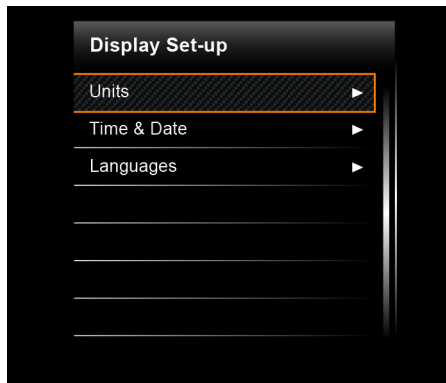

The following selections can be made from Display Set-up:

- Units, page 3.16
- Time & Date, page 3.17
- Language, page 3.17

Units

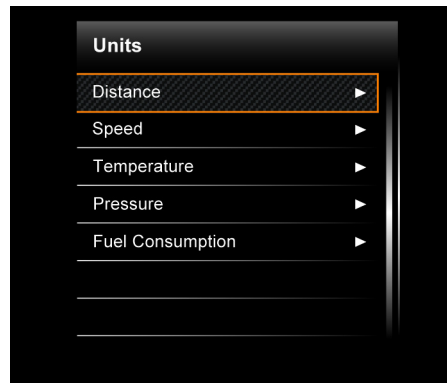

On the Units screen you can set the following units of measurement.

Distance - select miles or km.

Speed - select mph or km/h.

Temperature - select °C or °F.

Pressure - select kPa, bar or psi.

Fuel Consumption - select MPG, km/Litre or L/100 km.

The setting for your vehicle depends on the country or region where the vehicle was purchased. The units can be changed individually at any time.

Instruments

Instrument Cluster Display

Press and hold the OK button on the end of the control stalk to confirm your selections.

i NOTE: This feature also sets the units for the trip computer.

Time & Date

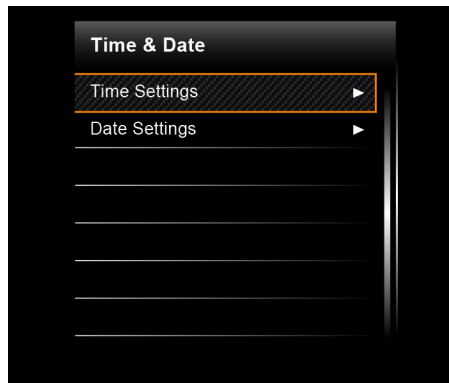

Set the Time before setting the Date.

Press and hold the OK button on the end of the control stalk to confirm your choice.

i NOTE: The time display can be set as 12 hour or 24 hour format.

i NOTE: The date display can be set as DD/MM/YYYY or MM/DD/YYYY.

Language



Use this screen to set your preferred language.

The following choices are available:

- English (UK)
- English (US)
- Arabic
- Chinese
- French
- German
- Italian
- Japanese
- Russian

Instruments

Instrument Cluster Display

- Spanish
- Portuguese
- Latin American Spanish
- Polish
- Korean
- Thai
- Turkish
- Hungarian
- Dutch

Press and hold the OK button on the end of the control stalk to confirm your choice.

If a language is not available on your vehicle, 'NOT SUPPORTED' will appear on the instrument cluster. Consult your McLaren retailer for further assistance.

Lighting

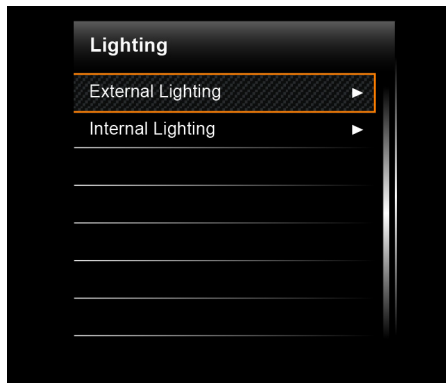

Select External Lighting, page 3.18, or Internal Lighting, page 3.19.

External Lighting

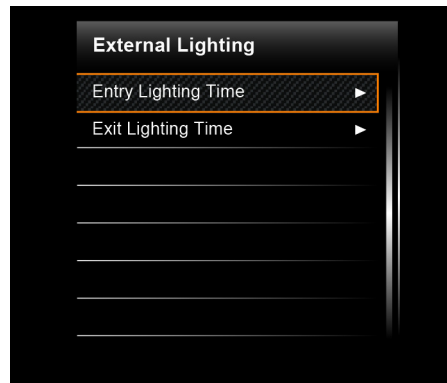

It is possible to set the duration that the external lights stay illuminated when locking and unlocking the vehicle.

Select the entry or exit lighting time from the instrument cluster screen, set the required time and press and hold the OK button on the end of the control stalk to confirm your selection.

Instruments

Instrument Cluster Display

Internal Lighting

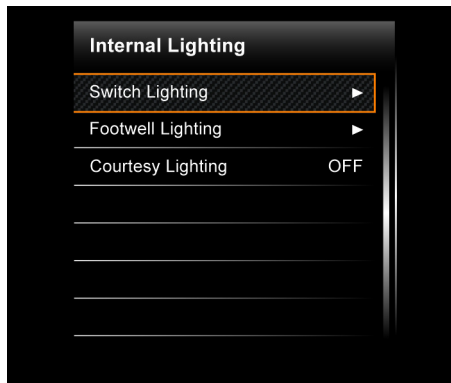

Select one of the following to adjust the illumination level:

- Switch Lighting
- Footwell Lighting

Press the control stalk down to quickly access switch lighting. A confirmation tone will be heard.

A gauge will appear. Move the control stalk up or down (SCROLL + or -) to highlight your preferred brightness level.

Press and hold the OK button on the end of the control stalk to confirm your choice.

Select courtesy lighting and pull the control stalk towards you to toggle the option 'ON' or 'OFF'.

Press and hold the OK button on the end of the control stalk to confirm your choice.

Vehicle

It is possible to make the following selections:

- Intake Sound Generator (ISG) (if fitted), page 3.20
- Valet Mode, page 3.21
- Reverse Select Tone, page 3.22
- Performance Shift Cue (PSC), page 3.22
- Navigation, page 3.23
- Auto Door Lock, page 3.23
- Auto Fold Mirrors, page 3.23
- Auto Alarm, page 3.23
- Road Speed Limit, page 3.23
- Door Unlock, page 3.23
- Comfort Entry/Exit, page 3.23
- Silent Lock, page 3.23
- Reverse Mirror Dip, page 3.24
- Tyre Type, page 3.25
- Wiper Modes, page 3.25
- Wiper Sensitivity, page 3.25

Instruments

Instrument Cluster Display

Intake Sound Generator (ISG) (if fitted)

You can change the level of sound entering the cabin for each powertrain mode selected.

⚠ WARNING: Operating and browsing menus whilst the vehicle is in motion could make you unable to observe road and traffic conditions and could cause an accident.

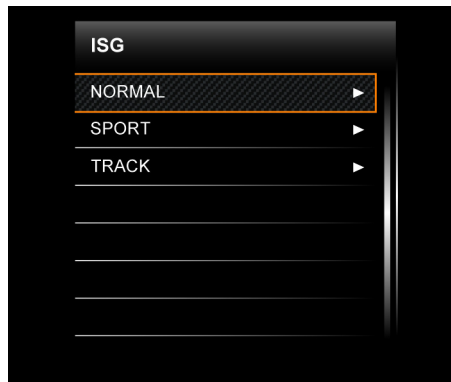

Three different powertrain modes will be displayed in the ISG menu.

Select the mode that you wish to change and a gauge showing the current ISG sound level for that mode will appear.

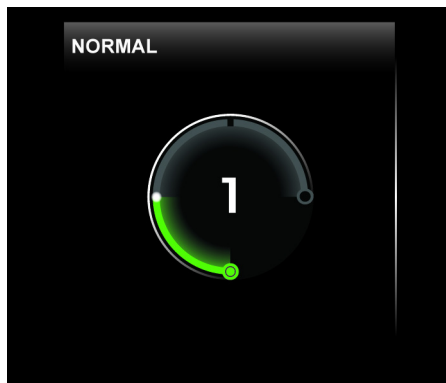

Move the menu control stalk up or down (SCROLL + or -) to achieve your preferred sound level for that powertrain mode. Press and hold the OK button on the end of the menu control stalk to confirm your choice.

The default settings for each mode are as follows:

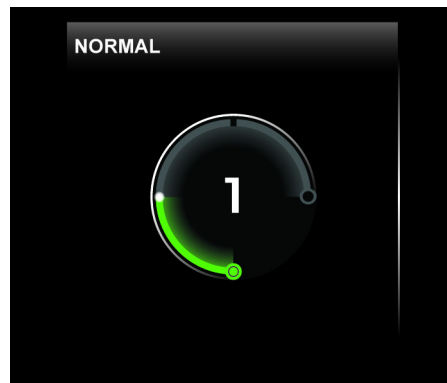

Normal - level 1

Instruments

Instrument Cluster Display

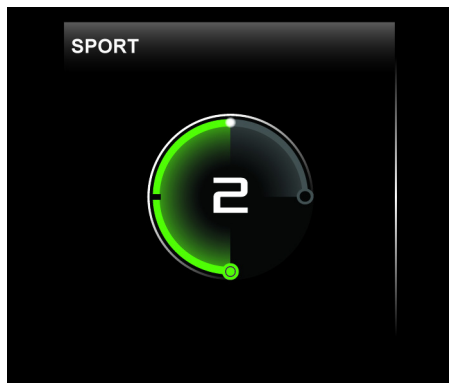

Sport - level 2

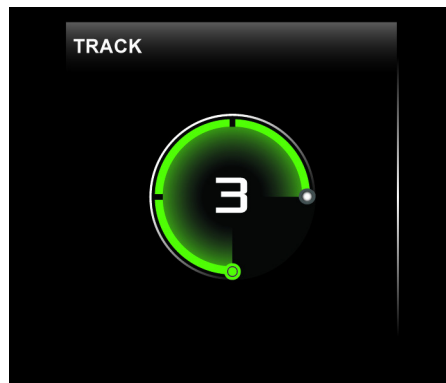

Track - level 3

i NOTE: These are the default settings for each mode, but you can apply any level of sound to any powertrain mode.

Valet Mode

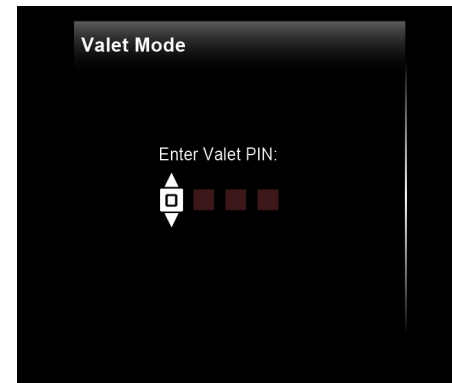

With Valet Mode on, the speed of the vehicle is limited to 35 mph (55 kph), the active dynamics panel is disabled, the luggage compartment, glove box, centre console stowage compartment and service cover remain locked, and a confirmation message appears on the instrument cluster.

To switch on Valet Mode you must input a PIN number after selecting the 'Valet Mode' from the Vehicle menu screen.

To enter the PIN, press the control stalk up or down until the first digit required appears on the instrument cluster, then press and hold

Instruments

Instrument Cluster Display

the OK button on the end of the control stalk to confirm your choice. An asterisk replaces each number as it is entered.

Repeat the process to enter the full PIN.

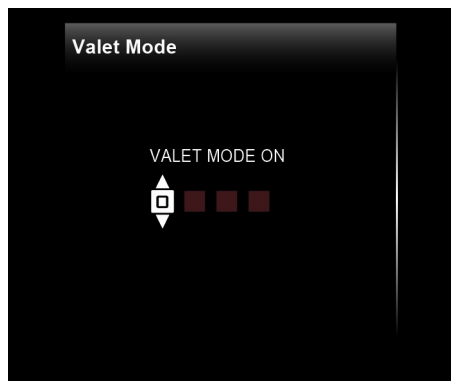

The factory set PIN number is 0000. Use this PIN the first time to switch on Valet Mode. You should change this PIN at the earliest opportunity.

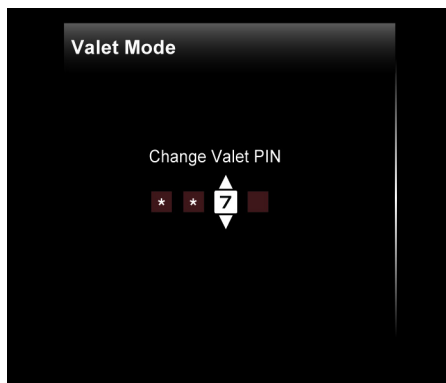

For a 5 second period after entering Valet Mode, the PIN can be changed by entering a new PIN using the same procedure described on this page.

When 'VALET MODE ON' is displayed, enter the PIN number to switch Valet Mode off.

Reverse Select Tone

When 'ON' is selected, a tone will sound as an audible indication that reverse gear has been selected. If 'OFF' is selected, the tone will be disabled.

Press and hold the OK button on the end of the control stalk to confirm your choice.

Performance Shift Cue (PSC)

PSC is an audible shift indicator, which will sound during full throttle acceleration in manual gearbox mode, to indicate that an upshift is required to maintain optimum performance.

When 'OFF' is selected, the PSC function will be disabled.

When 'SPORT & TRACK' is selected, PSC will be active in either Sport or Track powertrain or handling modes.

When 'TRACK ONLY' is selected, PSC will only be active in Track powertrain or handling modes.

Press and hold the OK button on the end of the control stalk to confirm your choice.

Instruments

Instrument Cluster Display

Navigation

When 'DISPLAY ON' is selected, current navigation turn-by-turn guidance will be displayed on the instrument cluster if route guidance has been started using IRIS. See Navigation, page 3.27.

If 'DISPLAY OFF' is selected, the turn-by-turn guidance on the instrument cluster will be disabled.

Press and hold the **OK** button on the end of the control stalk to confirm your choice.



NOTE: This option has no effect on the operation of the navigation system on IRIS.

Auto Door Lock

When you receive the vehicle, auto door lock will be set to on.

The vehicle doors will automatically lock as the vehicle moves off.

Switch auto door lock off, and the doors remain unlocked after moving off, unless, they are locked manually.

Press and hold the **OK** button on the end of the control stalk to confirm your choice.

Auto Fold Mirrors

When 'ON' is selected the exterior mirrors will fold as the vehicle is locked and unfold when the door is opened. If 'OFF' is selected, the mirrors will remain in their driving position.

Press and hold the **OK** button on the end of the control stalk to confirm your choice.

Auto Alarm

With auto alarm selected, the vehicle will automatically lock and the alarm set if unlocked and left for 30 seconds with all doors, luggage compartment lid and service access panels left fully closed.

Press and hold the **OK** button on the end of the control stalk to confirm your choice.

Road Speed Limit

When 'ON' is selected the speed limit for the current road will be displayed on the instrument cluster if available.

Press and hold the **OK** button on the end of the control stalk to confirm your choice.

Door Unlock

When 'DRIVER' is selected, only the driver's door will unlock when the vehicle is unlocked with either the key fob or door button.

When 'BOTH' is selected, both doors will unlock when the vehicle is unlocked using either the key fob or door button.

All closures will lock with either 'DRIVER' or 'BOTH' selected.

Press and hold the **OK** button on the end of the control stalk to confirm your choice.

Comfort Entry/Exit

When comfort entry/exit is 'ON', the driver's seat will move fully rearwards and to its lowest position when the ignition is off and the driver's door is opened. Seat memory - stalk return is activated along with this option, see Comfort entry, page 1.36.

When comfort entry/exit is 'OFF', the driver's seat will remain in position at all times.

Press and hold the **OK** button on the end of the control stalk to confirm your choice.

Silent Lock

When 'ON' is selected the direction indicators are disabled when locking or unlocking using the keyless entry system.

Instruments

Instrument Cluster Display

If 'OFF' is selected, the direction indicators always flash when the vehicle is locked or unlocked, irrespective of the method used.

All other lock and unlock features remain active.

Press and hold the **OK** button on the end of the control stalk to confirm your choice.

Reverse Mirror Dip

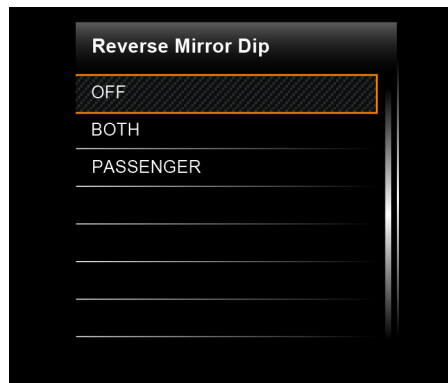

Select 'OFF', 'BOTH' or 'PASSENGER'.

'OFF' - no mirror dip will occur when reverse is engaged.

'BOTH' - both mirrors will dip when reverse is engaged.

'PASSENGER' - passenger's side mirror will dip when reverse is engaged.

Press and hold the **OK** button on the end of the control stalk to confirm your choice.

To set the amount the mirrors will dip when reverse is selected:

1. Switch the ignition on.

2. Select 'BOTH' or 'PASSENGER' in the mirror dip section of the cluster.
3. Depress brake and select reverse gear.
4. Adjust mirror(s) to desired position, see Adjusting mirrors, page 1.51.
5. Take vehicle out of reverse.

The next time reverse is selected, the vehicle will automatically move the mirror(s) to the previously set offset from the normal position.

Instruments

Instrument Cluster Display

Tyre Type

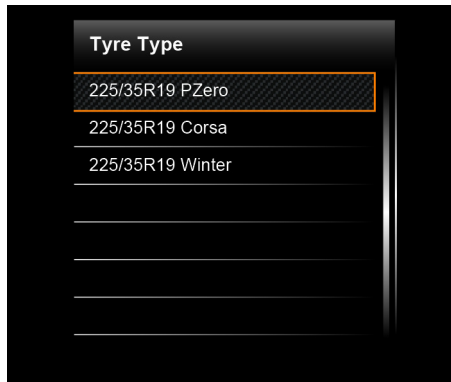

The display will show all the possible tyre types available. Select the tyres fitted to your vehicle.

Press and hold the **OK** button on the end of the control stalk to confirm your choice.

Wiper Modes

Select either 'AUTOMATIC' or 'TIMED'.

With 'AUTOMATIC' selected, wiper operation in the Auto position will be controlled by the rain sensor.

With 'TIMED' selected, wiper operation in the Auto position will be an intermittent wipe. To set the time delay for intermittent wipe, see Wiper Sensitivity, page 3.25.

Press and hold the **OK** button on the end of the control stalk to confirm your choice.

Wiper Sensitivity



A gauge will appear showing current wiper sensitivity setting. Move the control stalk up or down (**SCROLL +** or **-**) to achieve your preferred setting for the wiper operation. This setting will apply for the rain sensor sensitivity level only and will not affect the intermittent wipe time delay.

Press and hold the **OK** button on the end of the control stalk to confirm your choice.

Instruments

Instrument Cluster Display

Restore Default Settings

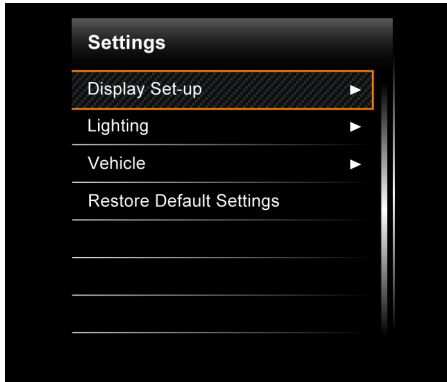

Select 'Restore Default Settings' then press and hold the OK button on the end of the control stalk to confirm that you wish to reset to the default settings.

Instruments

Instrument Cluster Display

Navigation

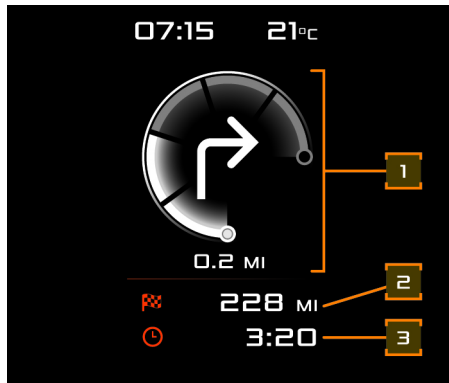

The current navigation turn-by-turn guidance will be displayed on the instrument cluster if route guidance has been started using IRIS.

The turn-by-turn display provides the following information:

1. Next turn direction and distance
2. Total distance to destination remaining
3. Total time to destination remaining

i NOTE: If no destination has been set using IRIS, only the compass and current road name will be displayed.

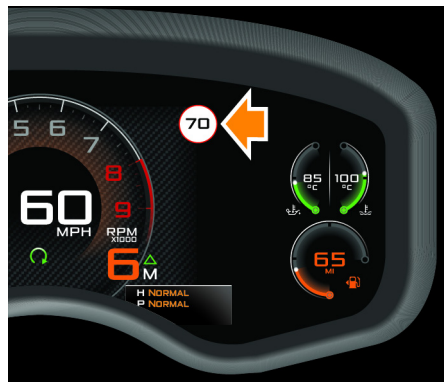

If available, the speed limit for the current road will be displayed on the instrument cluster.

i NOTE: The speed limit is for guidance only, always observe local speed limit information as there may be temporary or new speed restrictions in place.

i NOTE: The turn-by-turn and speed limit display can be switched off individually. See Settings, page 3.16.

Instruments

Instrument Cluster Display

Messages - Coupe, GT and Spider

The instrument cluster may show messages that refer you to the owner manual. The table below indicates what you should do when one of these messages is displayed.



WARNING: Do not ignore warning messages, failure to take appropriate action may result in injury or damage to the vehicle.

| Message | Action |
|----------------------------------|---|
| Battery management active | The vehicle is not be able to supply enough voltage and has activate power saving mode. The climate control and steering will operate with reduced effect. See Power saving mode, page 2.2. |
| Brake fluid level low | Top up brake fluid, see Brake fluid, page 5.9. |
| Clutch over temperature | The vehicle has been subject to extreme operating conditions. This may be caused by excessive hill starts, repeated hard acceleration, driving slowly up steep hills for extended periods. As a result, the gearbox may limit engine torque. Stop the vehicle and allow the engine to idle in neutral for a few minutes. |
| Clutch temperature high | The vehicle has been subject to extreme operating conditions. This may be caused by excessive hill starts, repeated hard acceleration, driving slowly up steep hills for extended periods. As a result, the gearbox may limit engine torque. Stop the vehicle and allow the engine to idle in neutral for a few minutes. |
| Engine oil level high | See Checking the engine oil, page 5.2. |
| Engine oil level low | See Checking the engine oil, page 5.2. |
| ESC OFF not possible | The ESC deactivation conditions have not been met. See Electronic stability control, page 2.31. |
| ESC reduced not possible | The ESC reduction conditions have not been met. See Electronic stability control, page 2.31. |
| Front left tyre over inflated | Stop the vehicle and inspect wheels and tyres, see Inspecting wheels and tyres, page 5.34. |
| Front left tyre over temperature | Stop the vehicle and inspect wheels and tyres, see Inspecting wheels and tyres, page 5.34. |

Instruments

Instrument Cluster Display

| Message | Action |
|---|---|
| Front left tyre pressure low | Stop the vehicle and inspect wheels and tyres, see Inspecting wheels and tyres, page 5.34. |
| Front right tyre over inflated | Stop the vehicle and inspect wheels and tyres, see Inspecting wheels and tyres, page 5.34. |
| Front right tyre over temperature | Stop the vehicle and inspect wheels and tyres, see Inspecting wheels and tyres, page 5.34. |
| Front right tyre pressure low | Stop the vehicle and inspect wheels and tyres, see Inspecting wheels and tyres, page 5.34. |
| Gear selection unavailable Front luggage not latched | Ensure front luggage compartment is latched securely before attempting gear selection. See Front luggage compartment, page 1.15. |
| Key battery critically low | See Replacing key fob battery, page 5.29. |
| Key battery low | See Replacing key fob battery, page 5.29. |
| Launch mode aborted | See Launch control, page 2.26. |
| Launch mode unavailable | The conditions to enable a Launch have not been met, see Launch control, page 2.26. |
| Rear left tyre over inflated | Stop the vehicle and inspect wheels and tyres, see Inspecting wheels and tyres, page 5.34. |
| Rear left tyre over temperature | Stop the vehicle and inspect wheels and tyres, see Inspecting wheels and tyres, page 5.34. |
| Rear left tyre pressure low | Stop the vehicle and inspect wheels and tyres, see Inspecting wheels and tyres, page 5.34. |
| Rear right tyre over inflated | Stop the vehicle and inspect wheels and tyres, see Inspecting wheels and tyres, page 5.34. |
| Rear right tyre over temperature | Stop the vehicle and inspect wheels and tyres, see Inspecting wheels and tyres, page 5.34. |
| Rear right tyre pressure low | Stop the vehicle and inspect wheels and tyres, see Inspecting wheels and tyres, page 5.34. |
| Steering fluid level low | Top up the power steering fluid, see Power steering fluid, page 5.8. |
| Windscreen washer fluid low | Top up windscreen washer fluid, see Windscreen washers, page 5.10. |

Instruments

Instrument Cluster Display

Messages - Spider Only

The instrument cluster may also show messages relating to the roof and refer you to the Owner Manual. The table below

indicates what these messages mean and what action you should take should you need to.

| Message | Action |
|--|---|
| Roof Operation In Progress | Message is displayed during a roof open/close cycle. See Retractable Roof - Spider models, page 1.18. |
| Roof Open | Message is displayed when the roof has completed the stow (open) cycle. See Retractable Roof - Spider models, page 1.18. |
| Roof Closed | Message is displayed when the roof has completed the raise (close) cycle. See Retractable Roof - Spider models, page 1.18. |
| Continue Roof Cycle | Message is displayed when the roof has been stopped in an intermediate position during a open/close cycle. Operate the roof switch in the desired direction. See Retractable Roof - Spider models, page 1.18. |
| Reduce Vehicle Speed, Release and Re-press Button For Roof Operation | Message is displayed if the vehicle has exceeded 25 mph (40 kph) during a open/close cycle. Reduce the vehicle speed and operate the roof switch in the desired direction. See Retractable Roof - Spider models, page 1.18. |
| Ambient Temp Too Low | Message is displayed if the ambient temperature is below -10°C (14°F). Roof operation will be inhibited until the ambient temperature has risen to allow safe operating level. See Roof Operating Temperature, page 1.19. |
| Hydraulic System Over Temperature | Message is displayed if the roof hydraulic system has become too hot. Roof operation will be inhibited until the hydraulic system cools to allow safe operating level. Please contact your McLaren Retailer. |
| Bad Supply Voltage - Start Engine | Message is displayed if the vehicle battery charge has become too low. Start the engine and allow the battery to be charged. Operate the roof switch in the desired direction. Please contact your McLaren Retailer. |
| Tonneau Operation In Progress | Message is displayed during tonneau cover open/close cycle. See Tonneau Cover - Spider models, page 1.23. |

Instruments

Instrument Cluster Display

| Message | Action |
|----------------------------------|--|
| Tonneau Open | Message is displayed when the tonneau has completed the open cycle. See Tonneau Cover - Spider models, page 1.23. |
| Tonneau Closed | Message is displayed when the tonneau has completed the close cycle. See Tonneau Cover - Spider models, page 1.23. |
| Roof Failure | Message is displayed if there is a operational malfunction. Roof operation will be inhibited. Please contact your McLaren Retailer. |
| Confirm Tonneau Empty | Message is displayed if the tonneau cover has been opened at any time whilst the roof has been raised and the roof or backlight switches have been pressed down to the lower (open) position. By releasing the switch and pressing OK on the menu control stalk, you confirm the tonneau area is empty and you accept if this is not the case that damage may occur to the retractable roof or backlight during operation. The roof or backlight will begin to lower (open) once the respective switch is pressed. See Retractable Roof - Spider models, page 1.18 and Backlight - Spider models, page 1.21. |
| Open Doors To Complete Operation | Message is displayed if the roof control unit is unable to confirm door status. Roof operation will be inhibited until the door status can be confirmed. Please contact your McLaren Retailer. |
| Continue Tonneau Cycle | Message is displayed when the tonneau cover has been stopped in an intermediate position during a open/close cycle. Operate the tonneau switch in the desired direction. See Tonneau Cover - Spider models, page 1.23 and Retractable Roof - Spider models, page 1.18. |

Instruments

Instrument Cluster Display

Display Window

Normal Mode



The display window provides the driver with visual access to the control settings and current performance values of the vehicle. The central display, as indicated above, is displayed when the vehicle is in Normal mode.

The information displayed on the centre section of the instrument cluster will change dependent on the mode selected. See Sport Mode, page 3.33 and Track Mode, page 3.34.

Instruments

Instrument Cluster Display

Sport Mode



The display window provides the driver with visual access to the control settings and current performance values of the vehicle.

The central display, as indicated above, is displayed when the vehicle is in Sport mode.

The information displayed on the centre section of the instrument cluster will change dependent on the mode selected.

See Normal Mode, page 3.32 and Track Mode, page 3.34.

Instruments

Instrument Cluster Display

Track Mode



The display window provides the driver with visual access to the control settings and current performance values of the vehicle. The central display, as indicated above, is displayed when the vehicle is in Track mode.

The information displayed on the centre section of the instrument cluster will change dependent on the mode selected.

See Normal Mode, page 3.32 and Sport Mode, page 3.33.

For more information regarding shift lights see Shift lights, page 3.2.

Instruments

Instrument Cluster Display

Gear Position Indicator

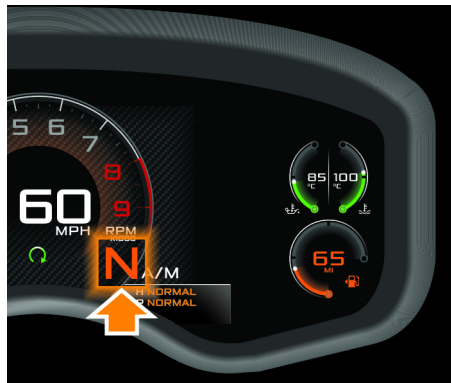

The gear indicator shows the current gear position selected: Neutral, Gear 1-7, or Reverse. The indicator will also show A or M depending on whether Automatic or Manual mode is selected.

The gear position indicator moves to the centre of the instrument cluster, swapping position with the speedometer, when the vehicle is in Sport or Track mode. See Sport Mode, page 3.33 and Track Mode, page 3.34.

For more information, see Manual/Automatic mode, page 2.18.

Handling and Powertrain Display

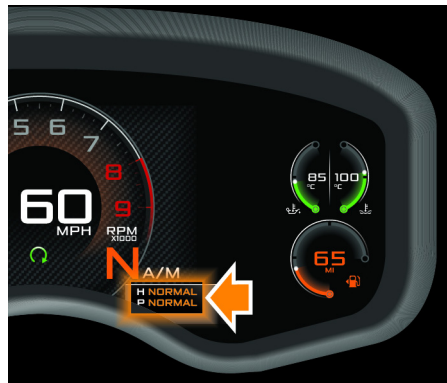

Confirmation of the handling and powertrain mode selected is displayed. For more information on the different settings that are available, see Active dynamics control, page 2.21.

i NOTE: If the ACTIVE button has not been pressed (active dynamics panel is off), the Handling and Powertrain displays will both show Normal and will be displayed in white.

The mode will not be implemented if all pre-conditions are not met.

Electronic Stability Control Mode Display

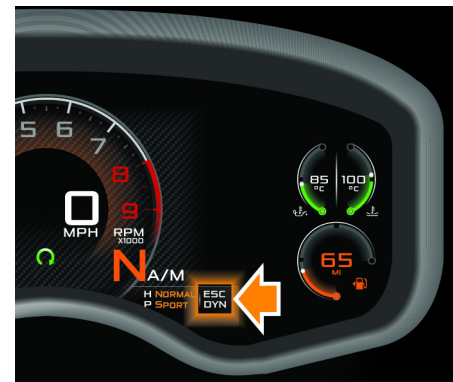

Confirmation of the Electronic Stability mode selected is displayed. For more information on the different settings that are available, see Active dynamics control, page 2.21.

Instruments

Instrument Cluster Display

Oil Temperature

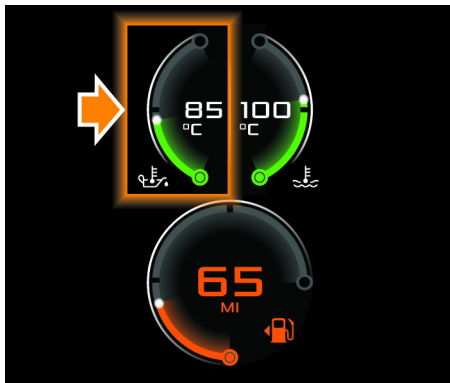

The oil temperature is displayed in the form of a coloured gauge on the right-hand side of the instrument cluster.

When the engine is first started the gauge will be BLUE. As the engine warms up the colour will change to GREEN, indicating normal temperature.

High temperature is indicated if the gauge turns ORANGE and excessive temperature is indicated by the gauge turning RED.

If the gauge shows high temperature, ORANGE, slow down until the temperature drops to normal. If the temperature continues to rise and the gauge turns RED, a warning message will appear on the instrument cluster.

Stop the vehicle as soon as safety permits and contact your McLaren retailer immediately.

Water Temperature



The water temperature is displayed in the form of a coloured gauge on the right-hand side of the instrument cluster.

When the engine is first started the gauge will be BLUE. As the engine warms up the colour will change to GREEN, indicating normal temperature.

High temperature is indicated if the gauge turns ORANGE and excessive temperature is indicated by the gauge turning RED.

Instruments

Instrument Cluster Display

If the gauge shows high temperature, ORANGE, slow down until the temperature drops to normal. If the temperature continues to rise and the gauge turns RED, a warning message will appear on the instrument cluster.

Stop the vehicle as soon as safety permits and contact your McLaren retailer.

Fuel Level and Range



Fuel level

The fuel level is displayed in the form of a coloured gauge on the right-hand side of the instrument cluster.

The gauge is green when there is more than approximately 11 litres (2.4 UK gallons) of fuel remaining in the tank.

The gauge turns AMBER when there is less than approximately 11 litres (2.4 UK gallons) of fuel remaining in the tank.

The gauge turns RED when there is less than approximately 5 litres (1.1 UK gallons) of fuel remaining in the tank.

Fuel range

Range is the estimated distance until the vehicle requires refuelling.

McLaren

Comfort and Convenience

| | |
|---|-------------|
| Windows | 4.2 |
| Safety | 4.2 |
| Opening and closing | 4.2 |
| Climate Control..... | 4.4 |
| Overview | 4.4 |
| Controls | 4.4 |
| Modes of Operation..... | 4.5 |
| A/C (Screen) Button..... | 4.6 |
| Demisting/Defrosting | 4.6 |
| Temperature Control..... | 4.7 |
| Air Recirculation Mode | 4.8 |
| Blower Speed Control..... | 4.8 |
| Air Distribution Settings..... | 4.9 |
| Heated seats..... | 4.10 |
| Heated mirror..... | 4.11 |
| System Calibration..... | 4.11 |
| Interior Features..... | 4.12 |
| Interior lighting..... | 4.12 |
| Entry lighting..... | 4.12 |
| Exit lighting..... | 4.13 |
| MSO Defined Electrochromatic Panoramic Roof | 4.13 |
| Stowage nets..... | 4.13 |
| Stowage compartments | 4.15 |
| Cup holders | 4.17 |
| Owner documentation | 4.17 |
| Sun visors | 4.18 |
| Accessory power sockets | 4.18 |
| USB sockets..... | 4.19 |

Comfort and Convenience

Windows

Safety

WARNING: Ensure that no one can be trapped as you open or close the windows. Do not rest any part of your body against the window. There is a risk of becoming trapped by the movement of the window. If there is a risk of entrapment, stop movement of the window.

Opening and closing

WARNING: The key fob allows the engine to be started and is also used to activate other features on the vehicle.

Take the key fob with you, every time you leave the vehicle to prevent unsupervised operation of the windows, which may result in injury.

Switches for both windows are located on the driver's door console. A switch for the passenger's window is located on the passenger's door console.

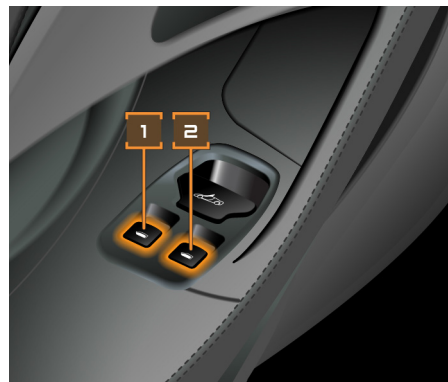

1. Driver's window switch.
2. Passenger's window switch.

Press switch (1) or (2). The window will open for as long as the switch is pressed.

Pull switch (1) or (2). The window will close for as long as the switch is pressed.

To open or close a window fully, press or pull switch (1) or (2) fully and release.

i NOTE: To stop a window opening or closing, press or pull the appropriate switch.

Comfort and Convenience

Windows

i NOTE: If the vehicle is in accessory mode, window control will not be available. If accessory mode is entered just after the engine has been stopped using the START/STOP button and the windows are not fully closed, window control will still be available until:

- the windows are fully closed
- the vehicle enters sleep mode
- a door is opened

Resetting the windows

The windows must be reset if the battery has been discharged or disconnected, or if the anti-trap feature has been activated.

Ensure that both doors are closed and the ignition is switched on.

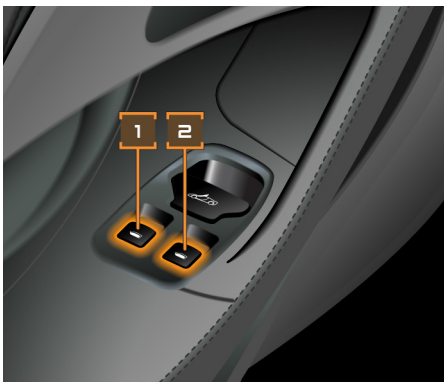

Push switches (1) and (2) downwards until the windows are open and hold them in this position for 5 seconds.

Pull both switches upwards until the windows are closed and hold them in this position for 5 seconds.

The windows are now reset.

If this does not resolve the issue, please contact your McLaren retailer immediately.

Anti-trap protection

⚠ WARNING: Do not leave children unattended in the vehicle, they could be injured by the movement of the window.

Anti-trap protection will stop windows closing if an obstruction or resistance is detected.

If the anti-trap protection is triggered, check the window and the window aperture and remove any obstruction, before operating the windows again. In the event of an anti-trap event when closing the door, see Closing a door, page 1.11.

Comfort and Convenience

Climate Control

Overview

The system can be operated in automatic mode or settings can be adjusted manually.

The combination filter reduces the quantity of dust and pollutants entering the vehicle.

⚠ WARNING: Follow the recommended settings given for heating or cooling. If the windows mist up, you may no longer be able to observe road and traffic conditions and could cause an accident.

i NOTE: The climate control system operates more effectively with the doors and windows closed. However, if the vehicle has been standing in a hot environment for a long time, ventilate by opening the windows briefly.

i NOTE: The interior air temperature sensor is located between the steering wheel and the centre console. Do not obstruct airflow to this sensor or the performance of the climate control system will be reduced.

i NOTE: The vehicle will retain the current climate control settings when the ignition is switched off.

Controls



The climate control system is operated using the touchscreen located on the centre console. Press the button to switch on the climate control screen.

Comfort and Convenience

Climate Control

Climate Controls

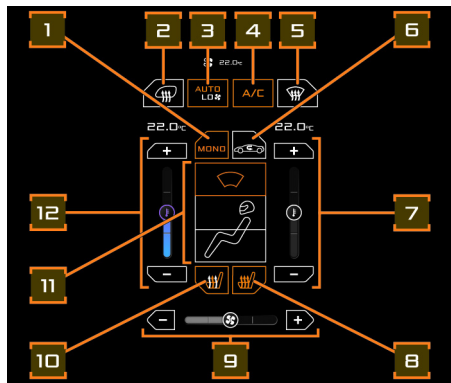

1. MONO button
2. Heated mirror button
3. AUTO/AUTO LO button
4. Air conditioning (A/C) button
5. Demist button
6. Air recirculation button
7. Temperature control - Right-hand side
8. Heated seat button - Right-hand side
9. Blower speed control
10. Heated seat button - Left-hand side
11. Air distribution buttons
12. Temperature control - Left-hand side

Modes of Operation

Automatic Mode

In automatic mode, the climate control system maintains the set interior temperature using a combination of differing blower speeds, air recirculation and air distribution.

The control panel uses different colours to indicate operational states:

- Orange indicates ON.
- White indicates OFF but available for use.
- Grey indicates not available for use.

To switch on automatic mode, touch the AUTO button.

The light on the button illuminates and the air distribution, temperature and blower speed are adjusted automatically on both sides of the vehicle.

In AUTO mode, there is no need to adjust the blower speed or air distribution, the system will operate whichever controls it needs to maintain the set temperature.

If you do wish to change the air distribution of the climate control system, touch the preferred button. This will then put the system into AUTO fan mode.

This is denoted by the colour of the blower speed slider. The bar is grey and the slider moves by itself when the blower is under automatic control. Here, the system is continuing to control the blower speed to maintain the set temperature. There is an additional mode known as AUTO LO. The AUTO LO function operates the fan at lower speeds to achieve and maintain the desired cabin temperature. This reduces the level of sound emitted from the climate control system whilst retaining auto functionality.

To switch on AUTO LO, press the AUTO button once when in AUTO mode. The AUTO LO symbol will change from white to orange.

To return to AUTO, press the AUTO button a single time.

If the blower speed is adjusted while AUTO LO is active the manual mode will be selected by default. If the AUTO button is then pressed the AUTO LO mode will be activated again. Pressing the AUTO button a second time will select the AUTO mode.

Comfort and Convenience

Climate Control

If necessary, the system settings can be manually adjusted, see Manual Mode, page 4.6.

Manual Mode

To adjust the air temperature, see Temperature Control, page 4.7.

To adjust the blower speed manually, see Blower Speed Control, page 4.8.

MONO Mode

MONO mode allows any changes the driver makes to their air temperature settings to be mirrored automatically to the passenger's temperature setting.

Touching the on-screen MONO button will cause it to illuminate and automatically implement the driver's air temperature settings to the passenger's side.

The driver can exit MONO mode at any time by a single touch of the MONO button. The MONO button on the screen will then extinguish.

A/C (Screen) Button

The A/C enhances cooling and dehumidifying of air. It is used by max-cooling and defrosting modes.

Use the A/C screen button as an ON/OFF switch.

Demisting/Defrosting

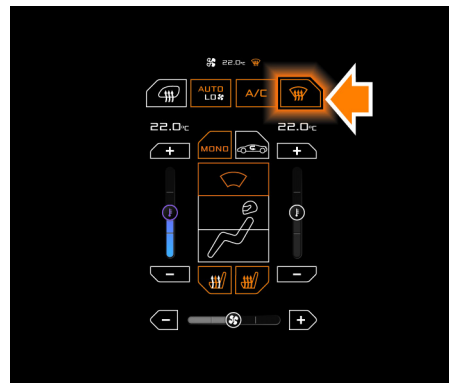

Touch the demist button to activate the screen demist function. The button will illuminate and an icon will be displayed at the top of the screen to indicate the function is active. The air conditioning switches on if previously off and the blower will operate at full speed with the air temperature set to 'HI'.

- i** NOTE: It is possible to manually reduce the blower speed, see Blower Speed Control, page 4.8.
- i** NOTE: Air recirculation is inhibited when demist mode is selected.

Comfort and Convenience

Climate Control

Touch the demist button again to exit the demist mode. The icon on the button extinguishes, and the air temperature and blower speed return to their original settings.

Temperature Control

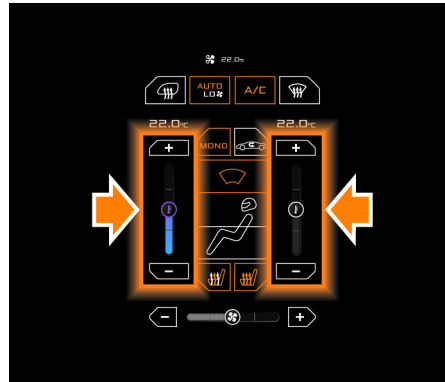

Touch the + button to increase the temperature, or touch the - button to decrease. Alternatively, touch the temperature control slider and drag it to the desired setting.

i NOTE: The temperature can be adjusted in 0.5°C (1°F) increments from 16°C to 28°C (61°F to 83°F) by using the + to increase and - to decrease the temperature, until the desired setting is achieved.

To set the temperature to maximum, touch the + button until 'HI' is displayed. In AUTO mode, the climate control system adjusts the air temperature to the highest setting, the blower speed is set to maximum and air is directed to the footwells.

To set the temperature to minimum, touch the - button until 'LO' is displayed. In AUTO mode, the climate control system sets the air temperature to the lowest setting, the blower speed is set to maximum and air is directed to the centre air vents.

The temperature set will appear on the display above the driver's and passenger's controls on the touchscreen.

i NOTE: With 'LO' selected, it is not possible to switch off the air conditioning.

Comfort and Convenience

Climate Control

Air Recirculation Mode

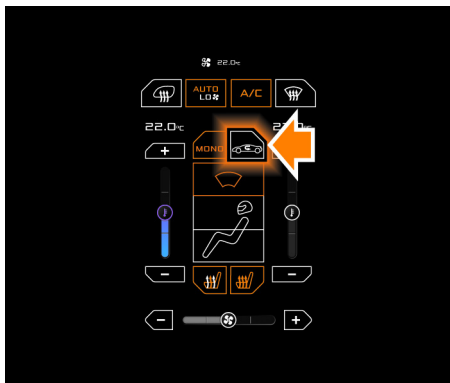

Select air recirculation when unpleasant smells or fumes are entering the vehicle. Air from outside the vehicle is now prevented from entering the cabin.

⚠ WARNING: Switch to air recirculation mode briefly if outside temperatures are low. Be aware that the windows could mist up, which may impair your visibility. As a result, you could be distracted from road and traffic conditions and cause an accident.

i NOTE: Switch on the air conditioning to prevent the windows misting.

Touch the air recirculation button, to activate air recirculation. The touch screen button will illuminate. To switch off air recirculation, touch the button again and the button illumination will be extinguished.

Blower Speed Control

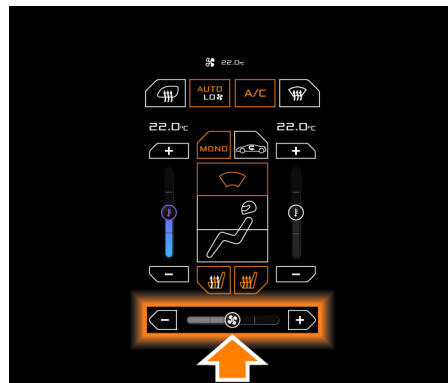

i NOTE: When the engine is first started, the blower speed is limited and the air is directed at the windscreen until the engine has warmed up.

The blower speed may be limited, dependent on the ignition.

i NOTE: When the engine is restarted from hot, the blower may operate at low speed. This removes warm air

Comfort and Convenience

Climate Control

from the vents, the blower speed will then increase to the requested setting.

Touch the + button to increase the blower speed, or touch the - button to decrease blower speed. Alternatively, touch the fan icon and drag it to the desired setting.

If in automatic mode, adjusting the blower speed will cause the AUTO button to extinguish.

Press the AUTO button to return to automatic mode.

Air Distribution Settings



The air distribution can be set using the air-distribution controls.

Press the top screen area to direct air to the windscreen, press the middle screen area to direct air to the centre air vents, press the bottom screen area to direct air to the footwell vents.

All three screen areas, a combination of any two or an individual area can be selected at any time.

When an air distribution screen area is pressed, the screen icon will illuminate.

Dashboard Air Vents





Turn a quarter turn in either direction until the vent is open or closed.

Comfort and Convenience

Climate Control

Heated seats

 **WARNING:** To avoid the risk of injury, constantly monitor the seat temperature.

 **WARNING:** The heated seats will not switch off automatically once it reaches its optimum temperature dependent on the level selected. Please ensure the switch of the heated seat function is turned off once the desired heat/period of heat has been achieved.

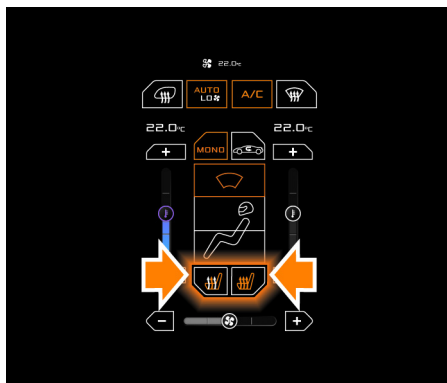

Touch the button once to switch seat heating on to the low temperature setting, the icon on the button will partially illuminate. Touch again to switch to the high temperature setting, the icon on the button will fully illuminate.

To switch off, touch the button again and the icon on the button will be extinguished.

The seat heater will remain in operation until switched off.

 **NOTE:** Seat heating is only available when the engine is running. If seat heating is not available, the button will appear greyed out.

 **NOTE:** Seat heating will switch off automatically when the engine is stopped by the Eco Start-Stop System, but will resume heating when the engine restarts. See Eco Start-Stop system, page 2.11.

Comfort and Convenience

Climate Control

Heated mirror

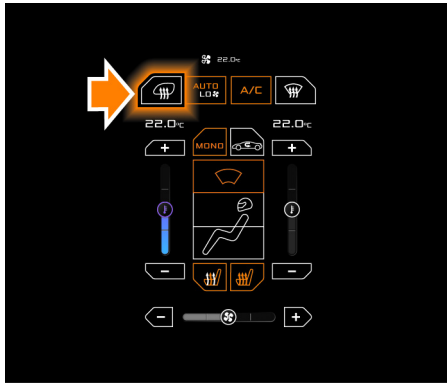

⚠ WARNING: Remove any accumulated ice or snow from the mirrors and windows before setting off. Impaired visibility could endanger yourself and others.

Touch the button to heat the exterior mirrors. The icon on the button will illuminate. To switch off, touch the button again and the icon on the button will be extinguished.

The heated mirrors switch off automatically after a set time, depending on the outside air temperature.

If the 'CALIBRATING' message does not disappear, contact your McLaren retailer.

System Calibration

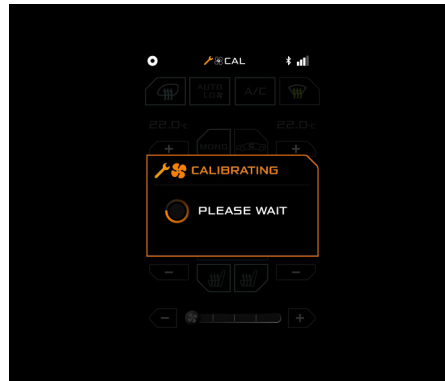

The climate control system may periodically re-calibrate itself to ensure optimum system performance is maintained. During this cycle, the 'CALIBRATING' message is shown on the display and system operation is inhibited.

Calibration should take no more than a minute and when complete the 'CALIBRATING' message will disappear from the display.

Comfort and Convenience

Interior Features

Interior lighting



1. Left-hand reading light on/off/gradual touch pad
2. Interior lighting on/off touch pad
3. Right-hand reading light on/off/gradual touch pad

For full interior lighting, press the touch pad (2) quickly.

i NOTE: Ensure that the interior lighting is switched off when leaving the vehicle.

To switch off the interior lighting, press touch pad (2) again.

Reading lights

Press touch pads (1) or (3) to switch on the desired reading light.

For gradual reading illumination, press and hold touch pad (1) or (3) until desired lighting is achieved.

Press touch pads (1) or (3) again to switch off the respective reading light.

Courtesy lighting

The interior of your McLaren is lit in the following areas:

- the driver's and passenger's footwells, when you open a door
- the centre console (illuminated by a light within the overhead light panel), if the ignition is on
- the interior door handles, if the ignition is on

The courtesy lighting extinguishes one minute after the doors have been closed or when the ignition is switched on.

The luggage compartment light illuminates when the luggage compartment is opened.

Entry lighting

Entry lighting improves visibility and security when you approach the vehicle.

When the vehicle is unlocked, the headlamps and tail lamps illuminate for a period of time or until the ignition is switched on.

To set the entry lighting duration, see External Lighting, page 3.18.

Comfort and Convenience

Interior Features

Exit lighting

Exit lighting improves visibility and security when you leave the vehicle by illuminating the headlamps and tail lamps for a period of time.

To set the exit lighting duration, see External Lighting, page 3.18.

Exit lighting can also be activated manually by pulling the direction indicator stalk towards you momentarily three times. The vehicle must be in an awake state with the ignition off.

Every additional pull on the direction indicator stalk whilst the exit lighting has been activated will increase the time increment by an additional 15 seconds.

Once the vehicle has been exited, locked and completed its set operating time, the exit lighting will be extinguished and the function will not be available, unless it is switched on in the instrument cluster or is manually activated again through the direction indicator stalk.

MSO Defined Electrochromatic Panoramic Roof



Use the touch panel to select the desired level of tint.

Touch in the direction of the Moon symbol to reduce the tint level.

Touch in the direction of the Sun symbol to increase the tint level.

Stowage nets

Bulkhead stowage net

⚠ WARNING: Do not carry unsecured objects inside the vehicle. Occupants could be injured by objects being thrown around during sharp braking, a sudden change of direction or an accident.

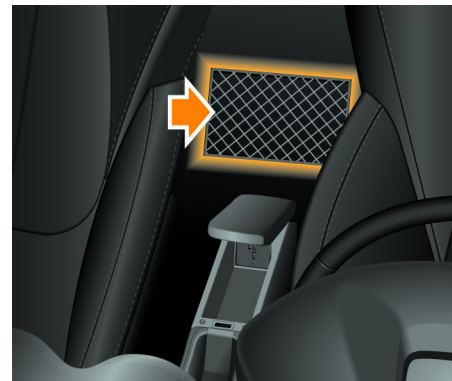

A stowage net is fitted on the bulkhead between the seats for storing small items.

i NOTE: The maximum weight the stowage pocket can support is 1 kg (2.2 lbs).

Comfort and Convenience

Interior Features

⚠ WARNING: Do not use the stowage net to transport any heavy, sharp-edged or breakable objects. Occupants could be injured by objects being thrown around during sharp braking, a sudden change of direction or an accident.

Passenger's footwell stowage net

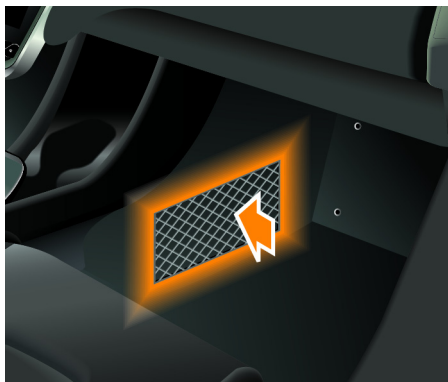

There is a stowage net in the passenger's footwell for storing small items.

i NOTE: Maximum item sizes for the passenger's stowage net are as follows:

- Maximum item size 1 - 250 mm Height x 200 mm Width x 20 mm Depth.
- Maximum item size 2 - 100 mm Height x 200 mm Width x Depth 70 mm.

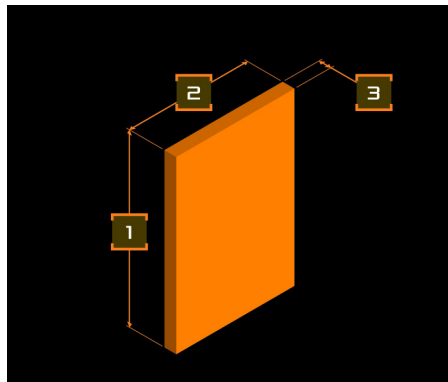

Passenger's footwell stowage net maximum item size 1 - 250 mm Height (1) x 200 mm Width (2) x 20 mm Depth (3).

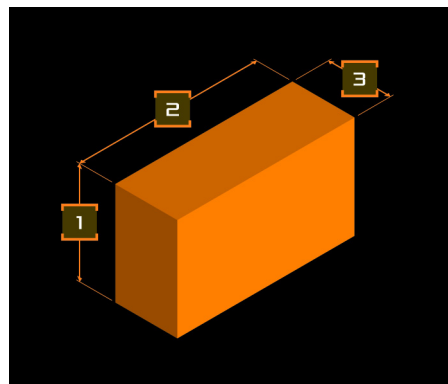

Passenger's footwell stowage net maximum item size 2 - 100 mm Height (1) x 200 mm Width (2) x Depth 70 mm (3).

⚠ WARNING: Do not place items in the passenger's footwell stowage net that exceed the dimensions stated previously. It could lead to personal injury or prevent the occupant restraint system from performing correctly.

⚠ WARNING: Do not use the stowage net to transport any heavy, sharp-edged or breakable objects. Occupants could be injured by

Comfort and Convenience

Interior Features

objects being thrown around during sharp braking, a sudden change of direction or an accident.

Stowage compartments

Glove box



A glove box is fitted on the passenger side of the dashboard for storing small items.

Depress the release button on the top of the dashboard, the glove box will automatically lower to an open position. To close, push the glove box up firmly and ensure that it is latched securely.

i NOTE: When the vehicle is locked or Valet Mode is on, the glove box will be locked and the release button disabled.

! WARNING: The glove box must be closed when items are stored in it. Occupants could be injured by objects being thrown around during sharp braking, a sudden change of direction or an accident.

Centre console stowage compartment

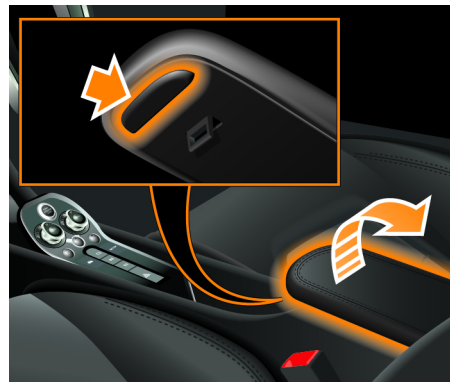

A compartment is fitted in the centre console for storing small items.

Depress the release button on the underside of the lid and lift to open. To close, push the lid down firmly and ensure that it is latched securely.

Comfort and Convenience

Interior Features

i NOTE: When the vehicle is locked or Valet Mode is on, the stowage compartment will be locked and the release button disabled.

! **WARNING:** The stowage compartment must be closed when items are stored in it. Occupants could be injured by objects being thrown around during sharp braking, a sudden change of direction or an accident.

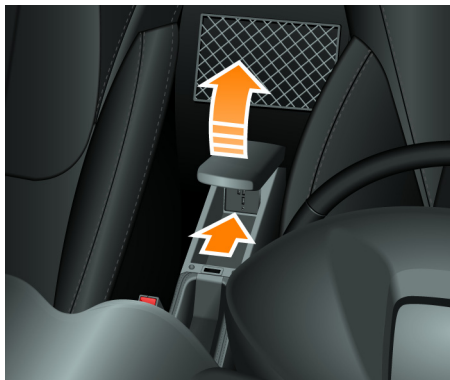

The USB and a 3.5 mm auxiliary audio input sockets are located in the stowage compartment. See USB sockets, page 4.19.

i NOTE: Always close the stowage compartment when leaving the vehicle, or the interior motion sensor (if fitted) will not function.

i NOTE: The area behind the seats is not designed for storing luggage or any other personal items.

Door stowage compartments

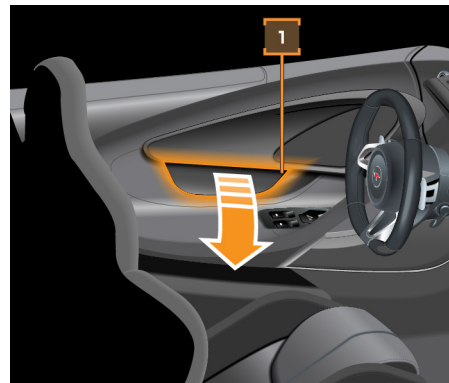

A compartment is fitted in each door for storing small items.

Pull the front edge of the lid to open, push back to close.

! **WARNING:** The stowage compartment must be closed when items are stored in it. Occupants could be injured by objects being thrown around during sharp braking, a sudden change of direction or an accident.

Comfort and Convenience

Interior Features

⚠ WARNING: The stowage compartment must not be opened when the door is open as there is a risk of objects falling out.

Seat stowage pocket

A pocket is fitted to the front edge of the driver's seat for storing small items.

Cup holders

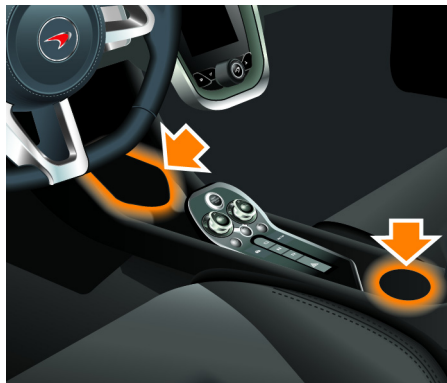

Utilise the cup holders for safe convenient storage of closed drink containers when on a journey.

⚠ WARNING: Drinking while the vehicle is moving could cause you to become distracted which could lead to an accident.

Owner documentation

Your McLaren is equipped with the following documents:

- Service and Warranty Guide - provides information on what to do and who to contact in the event of problems.
- IRIS User Guide - provides information on how to operate all the functions of the IRIS system fitted to your McLaren.

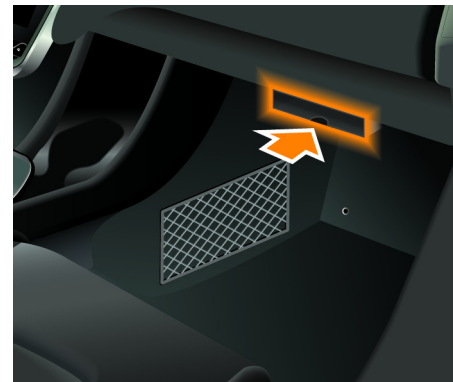

These documents can be stored in a slot under the dashboard on the passenger's side.

Comfort and Convenience

Interior Features

Sun visors



Fold the sun visors down to protect your eyes from bright sunlight as you are driving.

Vanity mirrors

Slide the panel on the sun visors to reveal a personal mirror.

Accessory power sockets



Luggage compartment socket

The accessory socket, located in the luggage compartment, has a maximum load rating of 20 Amps and is the only one that can be used to connect a McLaren supplied battery charger.

i NOTE: Do not leave any device (except a McLaren supplied battery charger), that draws power from the vehicle, connected to the socket for extended periods without the engine running. This may lead to excessive battery drain.

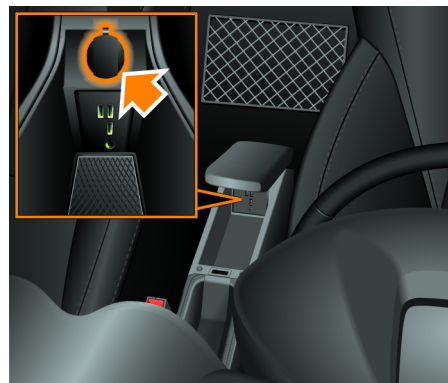

Interior accessory 12 V socket

The interior accessory 12 V socket is located inside the centre console storage compartment and has a maximum load rating of 15 Amps.

i NOTE: Do not connect a battery charger to the interior accessory socket.

Comfort and Convenience

Interior Features

USB sockets

Media USB sockets

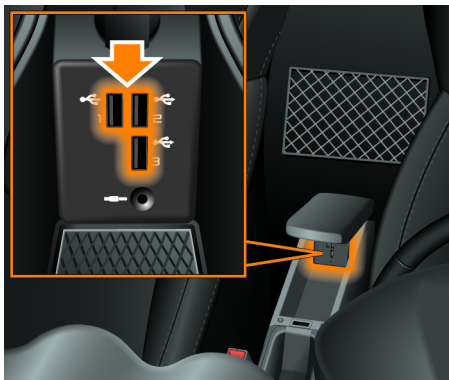

The media USB sockets are located inside the centre console stowage compartment.

The 3 media USB sockets can be used to connect USB flash drives, iPods and other compatible MP3 players to the IRIS system.

These sockets can also be used to charge compatible mobile phones or media devices.

i NOTE: If your vehicle is equipped with McLaren Track Telemetry (MTT), USB socket 3 will be replaced with a dedicated MTT socket.

McLaren Track Telemetry USB socket

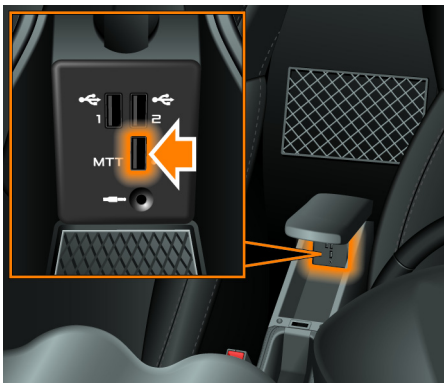

The McLaren Track Telemetry (MTT) USB socket is located inside the centre console stowage compartment, along with the media USB sockets.

Video and telemetry data from the MTT application will be saved to the USB flash drive connected to this socket.

i NOTE: The MTT application will automatically overwrite the files previously saved on any USB flash drive connected to this socket.

McLaren

Maintaining Your McLaren

| | | | |
|---|-------------|---|-------------|
| Fluid Topping Up | 5.2 | Manual Unlocking and Opening | 5.25 |
| Engine oil | 5.2 | Unlocking - discharged battery | 5.25 |
| Gearbox oil level..... | 5.5 | Starting the vehicle | 5.27 |
| Coolant..... | 5.6 | Door opening from inside - discharged battery | 5.27 |
| Power steering fluid | 5.8 | Opening luggage compartment - discharged battery..... | 5.28 |
| Brake fluid | 5.9 | Replacing key fob battery | 5.29 |
| Windscreen washers | 5.10 | Washers and Wipers | 5.30 |
| Emergency Equipment | 5.11 | Replacing the wiper blades..... | 5.30 |
| Emergency Equipment Safety..... | 5.11 | Wheels and Tyres | 5.32 |
| Luggage compartment equipment | 5.11 | Wheels and tyres..... | 5.32 |
| Warning triangle..... | 5.11 | Deflated tyre..... | 5.36 |
| First Aid kit | 5.12 | Vehicle Care | 5.38 |
| Tyre sealant..... | 5.12 | Washing your McLaren | 5.38 |
| Towing eye | 5.13 | Cleaning the interior | 5.40 |
| Fuel funnel..... | 5.13 | Car cover | 5.41 |
| Fire extinguisher | 5.13 | Raising the Vehicle | 5.42 |
| Battery Care and Maintenance | 5.14 | Vehicle lifting points..... | 5.42 |
| Battery safety..... | 5.14 | McLaren Assistance | 5.43 |
| Charging the battery..... | 5.14 | McLaren Assistance | 5.43 |
| Boost starting from another vehicle..... | 5.15 | Replacement battery | 5.43 |
| Fuses | 5.18 | In the event of a breakdown | 5.43 |
| Fuse replacement | 5.18 | Towing for recovery | 5.44 |
| Main fuse box..... | 5.18 | Driving Abroad | 5.45 |
| Secondary fuse box..... | 5.20 | Driving abroad | 5.45 |
| Battery fuse box..... | 5.21 | | |
| Lighting | 5.24 | | |
| Vehicle lights..... | 5.24 | | |

Maintaining Your McLaren

Fluid Topping Up

Engine oil

The engine uses approximately 0.1 litres of oil for every 625 miles (1,000 km), depending on your style of driving. The oil consumption may be higher than this when the vehicle is new or if you frequently drive at high engine speeds.

You will only be able to estimate the oil consumption after the vehicle has been driven for several thousand miles or kilometres.

i NOTE: Lubricant additives could damage the engine or gearbox. Damage caused by such additives is not covered by the vehicle warranty. Further information is available from your McLaren retailer.

Checking the engine oil

The engine oil level must be manually checked. No automatic level checks or warnings are provided.

To check the engine oil level manually:

1. Ensure the following conditions are met:
 - Vehicle stationary and positioned on a level surface.
 - Neutral selected and the foot brake applied (use left foot).

i NOTE: The foot brake must be applied for the entire duration of the oil level check.

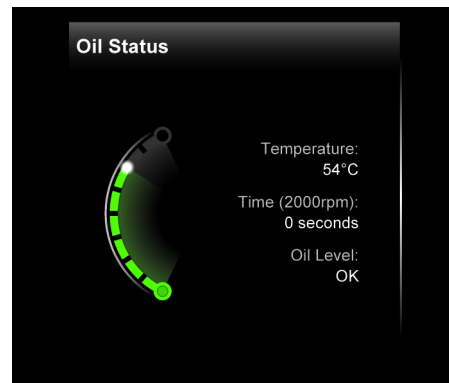

2. The level is viewed in the Vehicle Info section on the instrument cluster, see Vehicle Info, page 3.9.
3. Start the engine and hold the engine speed at 2,000 rpm for 40 seconds. Allow the engine oil temperature to reach a temperature of 70°C (158°F).

i NOTE: The throttle pedal can be fully depressed as the engine speed will be electronically limited to 2,000 rpm.

4. When the timer has reached '0', the oil level will be shown on the instrument cluster along with a description.

Maintaining Your McLaren

Fluid Topping Up

- i** NOTE: The line on the display indicates the maximum oil level for 19 seconds after the oil level is read.

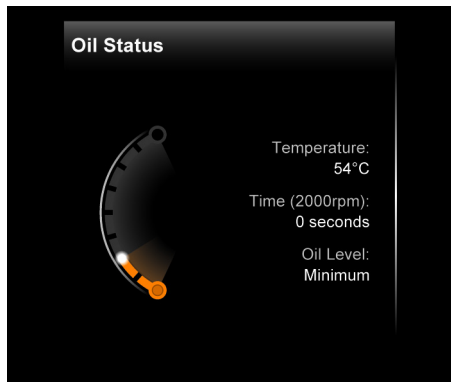

- If the engine oil is below the target level, top up the oil in accordance with the following procedure.

- i** NOTE: Once the oil level check has been completed and returned a value, do not continue to test the system. This may lead to aeration of the oil and return a false value. To end the oil level check, release the throttle pedal and return to the Vehicle info menu by moving the menu stalk back.

Topping up the engine oil

- !** WARNING: There is a risk of injury if the service cover is open, even when the engine is not running.

Engine components become very hot. Avoid contact, there is a risk of severe burns.

- !** WARNING: Never top up the engine oil and the coolant at the same time as there is a risk of cross contamination.

- !** WARNING: If the engine is stopped due to the Eco Start-Stop System you should be aware that the engine may restart without warning.

- i** NOTE: The engine must be switched off before carrying out the oil top up process.

1. Open the service cover.
See Service Cover - Coupe and Spider, page 1.12.
See Service Cover - GT, page 1.13.

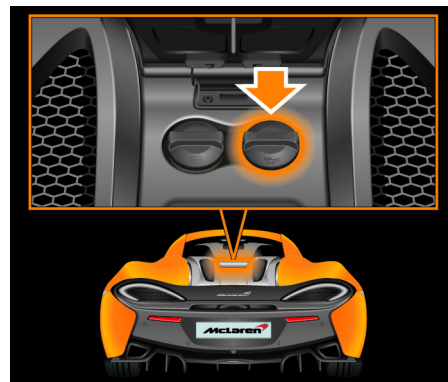

Coupe

2. Unscrew the engine oil filler cap.
3. Top up with the correct quantity of 0W-40 engine oil, in 0.25 litre quantities. Approximately 0.75 litres is required to raise the level from minimum to maximum. Refer to Top up quantity, page 5.5.

- i** NOTE: Do not overfill. Top up in 0.25 litre quantities and then re-check before adding further oil.

Maintaining Your McLaren Fluid Topping Up

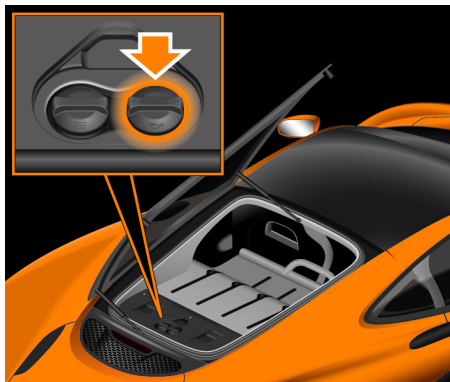

GT

4. Check the instrument cluster to ensure level is correct.

i NOTE: If you have inadvertently overfilled the engine with oil, you must have any excess removed at your McLaren retailer. The engine or the catalytic converter could be damaged.



5. Refit the engine oil filler cap.

🌱 ENVIRONMENTAL: When topping up, take care not to spill any oil. Oil must not be allowed to escape into the soil or waterways.

i NOTE: Ensure the oil filler cap is refitted correctly, with the markings on the cap and bowl aligned. If not, it may become detached and allow oil to escape the system.

6. Close the service cover
See Service Cover - Coupe and Spider, page 1.12.
See Service Cover - GT, page 1.13.

Maintaining Your McLaren Fluid Topping Up

Top up quantity

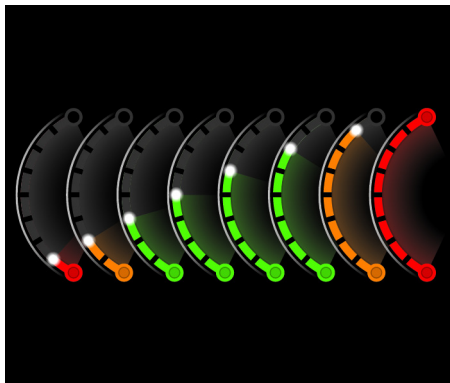

Based on the oil status displayed on the instrument cluster, add the required quantity of oil as shown in the following table.

| Segments on display | Quantity of oil required |
|------------------------|--------------------------|
| 1 - red - under filled | 1.00 litre |
| 2 - yellow - min. | 0.75 litre |
| 3 - green - OK | 0.50 litre |
| 4 - green - OK | 0.25 litre |
| 5 - green - OK | 0.10 litre |

| Segments on display | Quantity of oil required |
|----------------------|-------------------------------|
| 6 - green - target | 0 litre |
| 7 - yellow - max. | 0 litre |
| 8 - red - overfilled | Contact your McLaren retailer |

Oil temperature

If the oil temperature is too high, a warning will be displayed on the instrument cluster. Reduce the vehicle and engine speed until the warning message disappears.

Gearbox oil level

If you experience oil loss or problems with gear shifts, have the gearbox checked by your McLaren retailer.

i NOTE: The clutch and gearbox oil has mileage related service intervals. This maintenance can only be carried out by your McLaren retailer.

Maintaining Your McLaren Fluid Topping Up

Coolant

Coolant is a mixture of water and antifreeze/corrosion inhibitor. Only check the coolant when the vehicle is positioned on level ground and the engine is cool.

Topping up the coolant

! **WARNING:** The cooling system is pressurised. Only unscrew the cap when the engine is cool. You could be scalded by hot escaping coolant if you attempt to unscrew the cap whilst the engine is still warm.

! **WARNING:** Coolant is highly flammable. Fire, naked flames and smoking are prohibited when handling coolant.

! **WARNING:** Coolant is toxic. Keep containers sealed and away from children. If coolant is accidentally consumed, seek medical help straight away.

! **WARNING:** Never top up the engine oil and the coolant at the same time as there is a risk of cross contamination.

! **WARNING:** If the engine is stopped due to the Eco Start-Stop System you should be aware that the engine may restart without warning.

i **NOTE:** The engine must be switched off before carrying out the coolant level check and top up process.

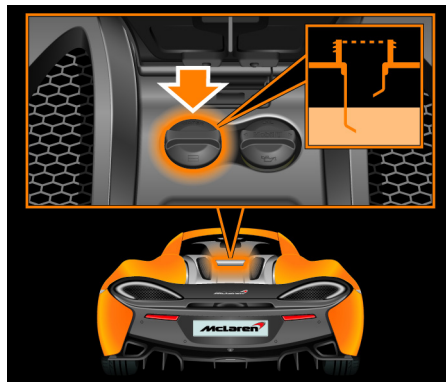

Coupe

1. Open the service cover.
See Service Cover - Coupe and Spider, page 1.12.
See Service Cover - GT, page 1.13.

2. Slowly unscrew the cap by half a turn anti-clockwise and allow excess pressure to escape.
3. Unscrew the cap fully and remove it.

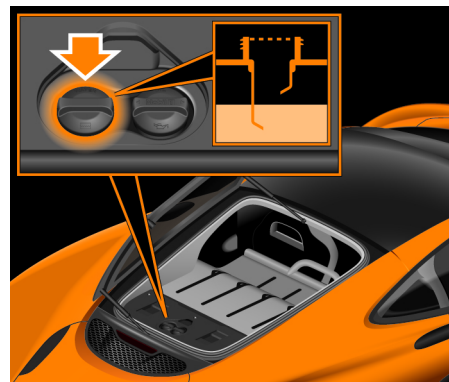

GT

4. The coolant level is correct when it is between the lower and upper steps inside the filler neck.
5. Top up if necessary.

Maintaining Your McLaren Fluid Topping Up



6. Replace the cap by turning it clockwise

to the stop.

- i NOTE: Ensure the cap is refitted correctly, with the markings on the cap and bowl aligned.
- 7. Close the service cover.
See Service Cover - Coupe and Spider, page 1.12.
See Service Cover - GT, page 1.13.

Maintaining Your McLaren Fluid Topping Up

Power steering fluid

 **WARNING: Power steering fluid is highly flammable. Fire, naked flames and smoking are prohibited when handling power steering fluid.**

 **WARNING: Power steering fluid is toxic. Keep containers sealed and away from children. If fluid is accidentally consumed, seek medical help straight away.**



Right-hand drive models

Checking fluid level





1. Switch the ignition on and start the engine. Select normal handling mode, see Handling control, page 2.22.
2. Allow the engine to idle for 20 seconds before checking the fluid level.
3. Open the luggage compartment, see Front luggage compartment, page 1.15.
4. Remove the access cover, then unscrew the cap anti-clockwise and remove it.
5. Measure the distance, inside the reservoir, down to the fluid level. Maximum fill level is 50 mm and minimum fill level is 55 mm from the top of the filler neck.
6. Top up if necessary using only Pentosin CHF202 power steering fluid, contact your McLaren retailer.
7. Replace the cap and access cover.
8. Close the luggage compartment, see Front luggage compartment, page 1.15.



Left-hand drive models

Maintaining Your McLaren Fluid Topping Up

Brake fluid

-  **WARNING:** Brake fluid is highly flammable. Fire, naked flames and smoking are prohibited when handling brake fluid.
-  **WARNING:** Brake fluid is toxic. Keep containers sealed and away from children. If fluid is accidentally consumed, seek medical help straight away.
-  **WARNING:** Only use fluid from new, air tight containers.
-  **NOTE:** Avoid spilling brake fluid, it is harmful to painted surfaces. Any spillages must be removed immediately with a mixture of car shampoo and water.
-  **NOTE:** The engine must be switched off before carrying out the brake fluid check and top up process.



Right-hand drive models

Checking fluid level

1. Open the luggage compartment, see Front luggage compartment, page 1.15.
2. Remove the access cover, then unscrew the cap anti-clockwise and remove it.
3. The brake fluid is correct if the level just covers the base of the filter in the filler neck.



Left-hand drive models

4. Top up if necessary using only new Pentosin DoT 5.1 brake fluid.
5. Replace the cap and access cover.
6. Close the luggage compartment, see Front luggage compartment, page 1.15.

Maintaining Your McLaren Fluid Topping Up

Windscreen washers

⚠ WARNING: Some washer fluids are highly flammable. Fire, naked flames and smoking are prohibited when handling washer fluid.

⚠ WARNING: Washer fluid is toxic. Keep containers sealed and away from children. If fluid is accidentally consumed, seek medical help straight away.

i NOTE: Add washer fluid to the reservoir all year round.

The reservoir for the windscreen washers is located in the luggage compartment.

The reservoir has a capacity of approximately 2.5 litres.

Checking fluid level

1. Open the luggage compartment, see Front luggage compartment, page 1.15.
2. Mix a solution of washer fluid concentrate and water in a container before adding to the reservoir. Concentration of the washer solution should be mixed to suit the outside temperatures.



3. Remove the access cover.
4. Open the reservoir cap, top up the reservoir with washer fluid and close the cap.
5. Replace the access cover.

6. Close the luggage compartment, see Front luggage compartment, page 1.15.

Maintaining Your McLaren Emergency Equipment

Emergency Equipment Safety

Before using the emergency equipment, familiarise yourself with the following safety information.

WARNING: Always ensure the emergency equipment supplied is used in the proper manner and for the purpose it was designed. Always use the emergency equipment in a safe and responsible manner and be aware of other road users.

Luggage compartment equipment



i NOTE: The towing eye is supplied fitted inside the first aid kit case, the fuel funnel is supplied with the vehicle.

Warning triangle



The warning triangle (1) is located at the front of the luggage compartment.

Maintaining Your McLaren Emergency Equipment

Setting up the warning triangle

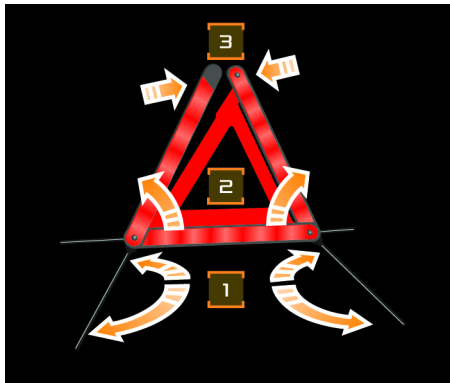

Fold the legs (1) sideways from the bottom.

Pull side reflectors (2) upwards to form a triangle and lock them at the top using press-stud (3).

Place the warning triangle at an appropriate distance from the vehicle to warn other traffic of a breakdown.

First Aid kit



The first aid kit (2) is located at the front of the luggage compartment.

i NOTE: Check the expiry dates of the first aid kit materials every 12 months, and replace them if necessary.

Tyre sealant



The tyre sealant (3) is located at the front of the luggage compartment.

For instructions on how to use the tyre sealant, see Deflated tyre, page 5.36.

i NOTE: Check the expiry date of the tyre sealant every 12 months, and replace if necessary.

Maintaining Your McLaren Emergency Equipment

Towing eye



The towing eye (4) is located inside the first aid kit case at the front of the luggage compartment.

i NOTE: Your McLaren is equipped with a front towing eye mounting only. It is not possible to tow other vehicles.

For information on installing the towing eye, see Towing eye and mounting, page 5.44.

Fuel funnel



The fuel funnel (5) is supplied with the vehicle.

i NOTE: Only use the fuel funnel when filling the vehicle with fuel from sources other than a fuel pump on a garage forecourt.

Do not use the fuel funnel when topping up coolant, engine oil or any other fluids in the vehicle.

Fire extinguisher



The fire extinguisher is located at the rear of the luggage compartment.

Release the retaining strap and remove the fire extinguisher.

To operate, follow the manufacturer's instructions on the side of the fire extinguisher.

i NOTE: The fire extinguisher must be checked every 12 months or it may fail in an emergency. Once the extinguisher is used it will have to be replaced.

Maintaining Your McLaren

Battery Care and Maintenance

Battery safety

Before using the battery charger, familiarise yourself with the following safety information.

 **WARNING:** Your McLaren is fitted with a lithium-ion battery. Only a lithium-ion battery charger can be used on this type of battery. Contact your McLaren retailer for more information.

 **WARNING:** The lithium-ion battery fitted to your McLaren is sealed for life and no attempt should be made to break the battery seal to inspect the battery cells.

 **WARNING:** Leave a suitable lithium-ion battery charger connected to the lithium-ion battery and switched on during periods when your vehicle is not in regular use. This will help maintain and prolong the life of the battery.

 **WARNING:** Before use, check that all cables are in good condition; do not use cables that are damaged.

Ensure that all cables are kept away from sharp edges, are not pinched or trapped and are not close to hot surfaces or water.

Never charge a damaged battery. The battery must only be charged in a well ventilated area; the charger must never be covered or placed on the battery.

Do not place any metal objects on a battery. You could cause a short circuit and the battery could ignite.

Keep the charger out of reach of children at all times.

Charging the battery

 **NOTE:** To maintain your lithium-ion battery in optimum condition, always leave the McLaren supplied battery charger connected to the battery and switched on during periods when your vehicle is not in regular use.

 **NOTE:** Do not connect the battery charger to the interior accessory socket.

Maintaining Your McLaren Battery Care and Maintenance



Refer to the instructions supplied with the battery charger. The charger connects to the accessory socket in the luggage compartment.

Boost starting from another vehicle

Using booster cables

- ⚠ WARNING:** Ensure that both batteries are 12 V and that the booster cables have insulated clamps and are approved for use with 12 V batteries.
- ⚠ WARNING:** Do not connect positive (+) terminals to negative (-) terminals.
- ⚠ WARNING:** Take care when working near rotating parts of the engine. Ensure cables are kept well clear.
- i NOTE:** Do not use a 24 V booster start system. These produce excessive voltage and can damage the vehicle's electrical system.
- i NOTE:** It is not possible to push or tow start a vehicle with a discharged battery.
- i NOTE:** If using a donor vehicle, please allow it to have the engine running for a minimum of 2 minutes before trying to start the disabled vehicle.

Boosting procedure

1. If a donor vehicle is to be used, park it so that the battery location is adjacent, but ensure the two vehicles do not touch.
2. Apply the parking brake and ensure that the transmission of both vehicles is set in neutral (or park for vehicles with automatic transmission).
3. Switch off the ignition and all electrical equipment in both vehicles.
4. Open the luggage compartment and remove any items stowed inside.

Maintaining Your McLaren Battery Care and Maintenance



5. Remove the 2 quarter turn screws securing the top of the battery access cover.



6. Open the top of the top of the battery access cover and disconnect the 2 electrical connectors on the back of the cover.
7. Lift the battery access cover upwards, off its locating pegs, and remove.

i NOTE: Before connecting the booster cables, ensure that the battery terminals on the disabled vehicle are correctly and securely connected and that all electrical equipment has been switched off.

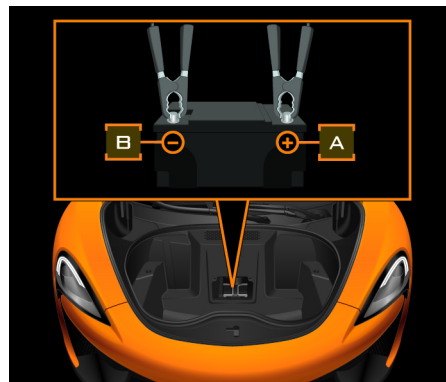

8. Connect one end of the positive (+) booster cable to the positive (+) terminal on the donor vehicle's battery.
9. Connect the other end of the positive (+) booster cable to the positive (+) terminal tab on the disabled vehicle's battery (A).
10. Connect one end of negative (-) booster cable to the negative (-) terminal on the donor vehicle's battery.
11. Connect the other end of the negative (-) booster cable to the negative (-) terminal on the disabled vehicle's battery (B).

Maintaining Your McLaren

Battery Care and Maintenance

12. Check that the cables are clear of any moving components and that all four connections are secure.

 **WARNING: Ensure that each connection is securely made and that there is no risk of the clips accidentally slipping or being pulled from the connection points/battery terminal - this could cause sparking, which could lead to fire or explosion.**

13. Start the engine of the donor vehicle and allow it to run for 2 minutes.
14. The electrical system on the disabled vehicle should now be ready for the engine to be started.
15. Start the engine of the disabled vehicle.
16. Allow both vehicles to idle for 2 minutes.
17. Switch off the donor vehicle.

 **NOTE: Do not switch on any electrical circuits on the previously disabled vehicle until after the booster cables have been removed.**

 **NOTE: If battery is fully discharged, or has been disconnected, it may be necessary to reset the windows, see Resetting the windows, page 4.3. If**

this does not resolve the issue, please contact your McLaren retailer immediately.

Disconnecting the cables

 **WARNING: To avoid serious injury, use caution when removing the booster cables as the engine on the previously disabled vehicle will be running. You will be working close to components carrying high voltage, or may be hot.**

1. Disconnect the booster cables in the reverse order to that used for connection.
2. Refit the battery access cover, connect the 2 electrical connectors and secure with the 2 screws.

Maintaining Your McLaren

Fuses

Fuse replacement

⚠ WARNING: Fuses protect the vehicle's electrical systems. The failure of any fuse will render the system it protects inoperative.

Use replacement fuses of the same rating and type. Incorrect fuse ratings can overload a system and cause a fire or malfunction. Blown fuses should be replaced and no attempt should be made to repair a blown fuse.

i NOTE: Before removing a fuse, turn off all electrical equipment and switch off the ignition.

There are three fuse boxes fitted to your McLaren.

| Fuse Box | Location |
|--------------------|---|
| Main fuse box | Behind a panel in the rear bulkhead, behind the left-hand seat. |
| Secondary fuse box | Below the dashboard on the passenger's side. |

| | |
|------------------|---|
| Battery fuse box | On top of the battery, in the luggage compartment, beneath the luggage compartment cover. |
|------------------|---|

Main fuse box

Main fuse box access



1. To access the main fuse box:
 - if a manual seat is fitted, lift the tilt release lever and tilt the left-hand seat backrest forwards
 - if an electric seat is fitted, pull the release strap (shown above) and tilt the left-hand seat backrest forwards
 - if a racing seat is fitted, slide the racing seat forwards

Maintaining Your McLaren Fuses



2. Release the two lower clips securing the panel to the bulkhead and remove the panel
3. Refer to the fuse specification chart on Main fuse box fuse specification chart, page 5.19 to determine which fuse protects the non-functioning electrical system.

i NOTE: A label identifying the fuses is attached to the inside of the access panel.

4. Remove the appropriate fuse and replace it with a fuse of the same value as the original. If in doubt, check the fuse specification chart.

5. Fit the access panel by inserting the two upper retaining clips in the bulkhead and securing with the two lower clips.

i NOTE: If a replacement fuse does not solve the electrical problem, or it fails immediately, contact your McLaren retailer.

Main fuse box fuse specification chart

| No. | Amps | Circuit protected |
|-----|------|----------------------------------|
| F1 | 60 | Secondary Air Pump |
| F2 | 60 | Secondary Air Pump |
| F3 | - | - |
| F4 | - | - |
| F5 | 30 | Powertrain Chassis Control Unit |
| F6 | 30 | Powertrain Chassis Control Unit |
| F7 | 30 | Starter |
| F8 | 30 | Heated Rear Window and Umbilical |
| F9 | 30 | Audio Amplifier (Tier 3) |
| F10 | 40 | Roof Pump - Spider |

| No. | Amps | Circuit protected |
|-----|------|---------------------------------|
| F11 | 20 | Roof ECU - Spider |
| F12 | - | - |
| F13 | 5 | Powertrain Chassis Control Unit |
| F14 | 5 | Engine Control Module |
| F15 | 10 | Relays |
| F16 | 10 | OBD Diagnostics |
| F17 | 3 | Door Locking Switch |
| F18 | 50 | ECU Main Relay Control |
| F19 | - | - |
| F20 | 30 | Seat Driver's |
| F21 | 30 | Seat Passenger's |
| F22 | 50 | Fuel Pump 1 |
| F23 | 5 | Tilt and Microwave Sensor |
| F24 | 15 | Audio Amplifier (Tier 1 & 2) |
| F25 | 10 | Driver's/Passenger's Door Latch |
| F26 | 10 | ICPC |
| F27 | 15 | Audio Amplifier (Tier 1 & 2) |
| F28 | - | - |

Maintaining Your McLaren Fuses

| No. | Amps | Circuit protected |
|-----|------|---|
| F29 | - | - |
| F30 | - | - |
| F31 | 50 | Cooling Fan Left-Hand |
| F32 | 50 | Cooling Fan Right-Hand |
| F33 | - | - |
| F34 | 20 | Wheel Arch Fan |
| F35 | - | - |
| F36 | 20 | Battery Main Relay |
| F37 | 15 | Canister Purge |
| F38 | 15 | Fuel Injection and Ignition - Left-Hand Bank |
| F39 | 15 | Fuel Injection and Ignition - Right-Hand Bank |
| F40 | 10 | Engine Ancillaries |
| R41 | - | Wheel Arch Fan |
| R42 | - | - |
| R43 | - | - |
| R44 | - | - |
| F45 | 10 | Electrical Thermostats, Camshaft Actuators |

| No. | Amps | Circuit protected |
|-----|------|---------------------------------|
| F46 | 3 | Engine Ancillaries |
| F47 | 3 | Engine Ancillaries |
| F48 | - | - |
| F49 | 5 | Starter |
| R50 | - | - |
| R51 | - | Heated Rear Window |
| R52 | - | - |
| R53 | - | Powertrain Chassis Control Unit |
| R54 | - | Powertrain Chassis Control Unit |
| R55 | - | Starter |
| R56 | - | Secondary Air Pump |
| R57 | - | Cooling Fans |
| R58 | - | ECU Main relay Control |

Secondary fuse box

Secondary fuse box access

1. Access to the secondary fuse box is gained by lowering the closing panel below the dashboard on the passenger's side.

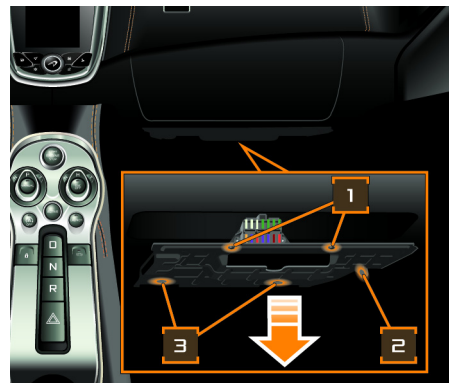

2. Remove the two front screws (1).
3. Remove the side fixing clip (2).

i NOTE: If you wish to lower the closing panel fully, also remove the two clips at the rear (3).

4. Lower the closing panel, sufficiently to gain access to the fuse box.

Maintaining Your McLaren Fuses

i NOTE: Do not lower the closing panel further than necessary as it could be damaged.

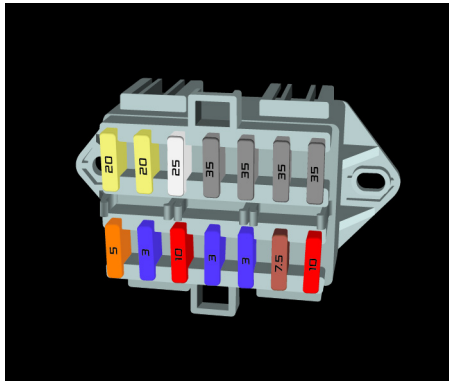

5. Remove the appropriate fuse and replace it with a fuse of the same value as the original. If in doubt, check the fuse specification chart.
6. Raise the closing panel into position, fit the clip and fit and tighten the two front screws.

Secondary fuse box fuse specification chart

| No. | Amps | Circuit protected |
|-----|------|-----------------------|
| F1 | 20 | Driver's door |
| F2 | 20 | Passenger's door |
| F3 | 25 | Lights |
| F4 | 35 | Lights |
| F5 | 35 | Body |
| F6 | 35 | Body |
| F7 | 35 | Alarm |
| F8 | 3 | Off Board AM/FM Tuner |
| F9 | 3 | USB AUX Module |
| F10 | 10 | Air conditioning |
| F11 | 3 | Alarm Control Unit |
| F12 | 3 | Tracker |
| F13 | 7.5 | Alarm |
| F14 | 10 | Instrument cluster |

Battery fuse box

Battery fuse box access

1. Open the luggage compartment lid and remove any items stowed inside.



2. Remove the 2 screws securing the top of the battery access cover.

Maintaining Your McLaren Fuses



3. Open the top of the battery access cover and disconnect the 2 electrical connectors on the back of the cover.
4. Lift the battery access cover upwards, off its locating pegs, and remove.

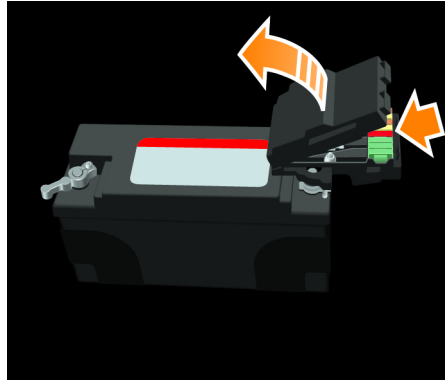

5. Press the 2 catches on the right-hand side of the cover and remove the cover from the fuse box.

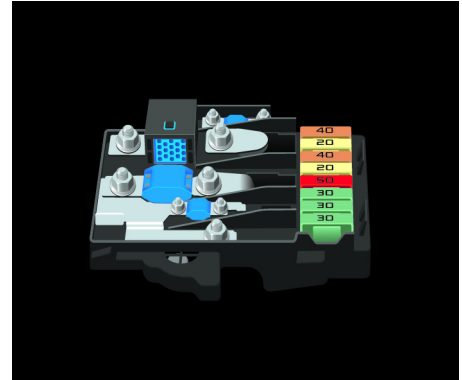

6. Remove the appropriate fuse and replace it with a fuse of the same value as the original. If in doubt, check the fuse specification chart.
7. Engage the left-hand side of the cover with the fuse box, and push the right-hand side down to fully engage the clips.
8. Refit the battery access cover, connect the 2 electrical connectors and secure with the 2 screws.
9. Stow the contents removed from the luggage compartment.

Maintaining Your McLaren Fuses

Battery fuse box fuse specification chart

| No. | Amps | Circuit protected |
|-----|------|--|
| 1 | - | - |
| 2 | - | - |
| 3 | 30 | Air Conditioning - Motor - Control Module |
| 4 | 50 | Secondary Fuse Box Supply |
| 5 | 20 | Electronic Stability Control valves |
| 6 | 40 | Electronic Stability Control motor |
| 7 | 20 | Auxiliary Power Socket - Luggage Compartment |
| 8 | 40 | Secondary Fuse Box Supply |
| 9 | 100 | Electro Hydraulic Power Assisted Steering |
| 10 | 200 | Main Fuse Box Supply |
| 11 | - | - |

Maintaining Your McLaren Lighting

Vehicle lights

Lighting is an important aspect of vehicle safety. You must ensure that all lights are working at all times.

All the external lights on your McLaren use the latest Light Emitting Diode technology.

Unlike traditional filament bulbs, these lights have a long life and low power consumption while providing the same amount of illumination.

Headlamps

Your McLaren is fitted with Light Emitting Diode headlamps. These provide greater visibility on both dipped and main beams, especially during adverse weather and driving conditions.



NOTE: Do not attempt to change Light Emitting Diodes yourself, as you could damage the vehicle lighting systems. In case of failure, contact your McLaren retailer.

Maintaining Your McLaren

Manual Unlocking and Opening

Unlocking - discharged battery

If you are unable to lock or unlock the vehicle because the vehicle battery or key fob battery has become discharged, use the mechanical key.

i NOTE: In the event of an extremely low state of battery charge, the windows will lower slightly so that the left-hand door can be opened with the manual key. The alarm system will be disarmed to prevent the alarm sounding.

Unlocking and opening procedure

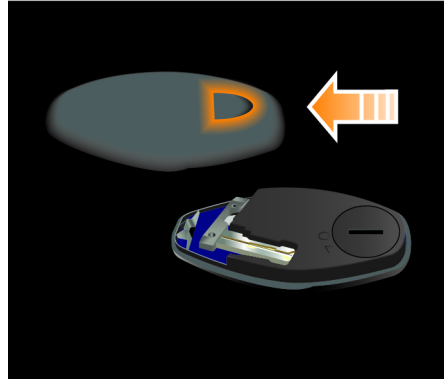

1. Push against the thumb indent and slide the back cover away from the key fob.

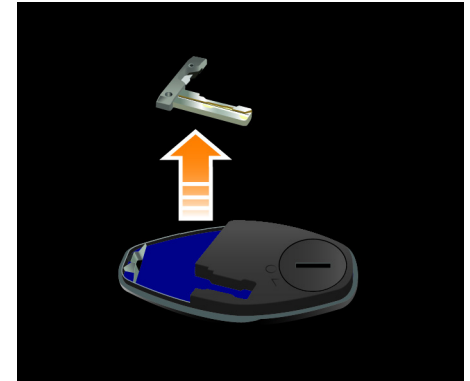

2. Release and remove the mechanical key from the key fob.

Maintaining Your McLaren Manual Unlocking and Opening

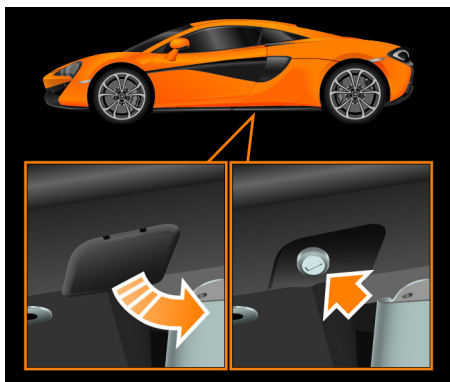

3. The mechanical lock is located below the door on the sill panel, underneath a removable panel.
4. Remove the panel by placing your fingers in the recess and pulling outwards.

i NOTE: The panel is not tethered to the vehicle and can be removed completely. Ensure that the panel is stored safely and cannot be damaged when the mechanical key is used.

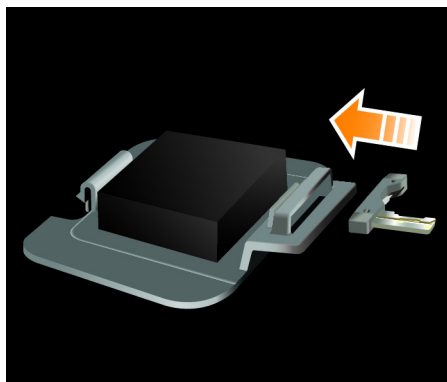

5. Insert the mechanical key into the slot on the removed panel.

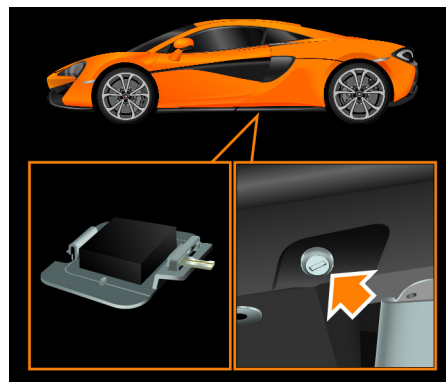

6. Insert the mechanical key into the lock and, using the attached panel for leverage, turn the key until mechanical resistance is preventing full release of the door.
7. Apply pressure to the latch area of the door (to counteract pressure of the door seals), and turn the key further to release the door.

i NOTE: If the vehicle battery is discharged and if the windows have not lowered. Take care when opening or closing the door. Do not force the door open or closed, the door seals or window could be damaged.

Maintaining Your McLaren Manual Unlocking and Opening

- Fit the mechanical key back into the key fob.

i NOTE: Unlocking the vehicle using the mechanical key will activate the anti-theft system and may cause the alarm to sound. Once the door is open, place the key fob on the section of the cup holder housing immediately behind the switch panel. within 10 seconds. The vehicle will recognise the key fob and stop the alarm from sounding.

- If the key fob battery has become discharged, replace the battery at the earliest possible opportunity, see Replacing key fob battery, page 5.29.

- Replace the cover panel.

Starting the vehicle



If the key fob battery has become discharged, and the engine will not start, present the key fob close to the dedication plate behind the switch panel.

In this position the vehicle is able to sense the presence of the valid key fob and the vehicle can be started and driven.

Replace the key fob battery at the earliest possible opportunity, see Replacing key fob battery, page 5.29.

Door opening from inside - discharged battery

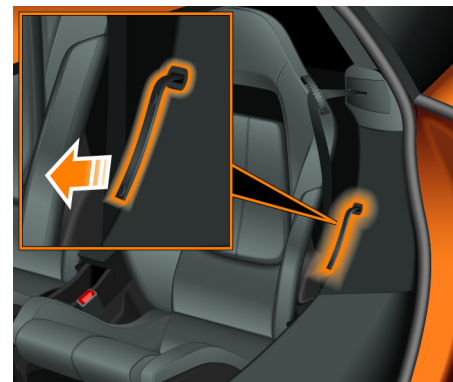

To release a door from inside, release the manual door release strap retainer and pull the strap.

The door latch will then release, allowing the door to be partially raised before it automatically swings outwards and upwards.

To refit the release strap, feed the strap into its holder and snap the retainers into place.

i NOTE: Only use this strap when the battery has become discharged.

Maintaining Your McLaren Manual Unlocking and Opening

i NOTE: Please ensure that both of the retainers on the manual door release strap are fitted correctly, and in the correct positions on the door aperture after use.

i NOTE: Please ensure that the manual door release strap is fully retracted before fitting the retainers to their door aperture locations.

Opening luggage compartment - discharged battery

i NOTE: The key fob or luggage compartment button on the centre console will not release the luggage compartment if the battery is discharged or disconnected. In the event of this use the manual release mechanism.

Opening procedure

1. Push the handle in the left-hand door aperture.
2. The luggage compartment will fully unlock and open slightly.
3. Lift the front of the luggage compartment lid, the gas struts will support it in the fully open position.

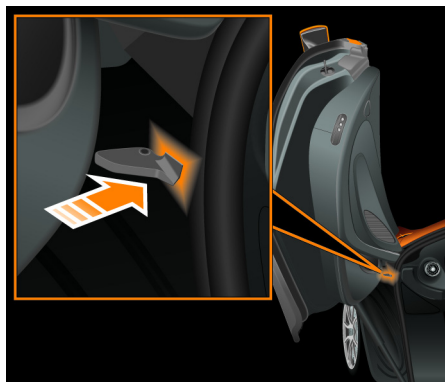

Maintaining Your McLaren

Manual Unlocking and Opening

Replacing key fob battery

Fit a new key fob battery every 24 months. You can do this yourself, or entrust it to your McLaren retailer.

When the key fob battery is discharged, you will only be able to unlock the vehicle with the mechanical key.

You will require a single CR2032 3 V battery.

 **WARNING: The battery contains toxic substances. If a battery is swallowed, contact a doctor immediately.**

 **ENVIRONMENTAL:** Do not dispose of the battery with the household waste. Batteries contain toxic substances.

Take the discharged battery to your McLaren retailer or to a recycling point for used batteries.

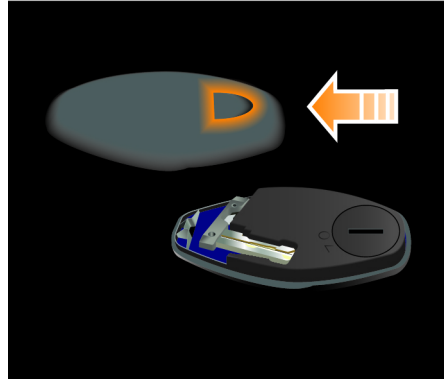

1. Push against the thumb indent and slide the back cover away from the key fob.

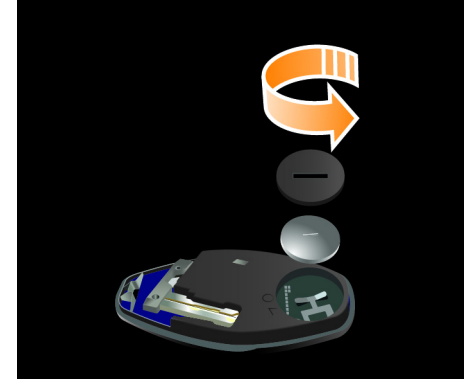

2. Unscrew the battery cover and remove the discharged the battery.
 3. Install a new battery, ensuring that the polarity is correct.
-  **NOTE:** Handle the battery as little as possible. Moisture and oil from fingers can affect battery life and cause corrosion of the contacts. Only hold the battery on the edges.
4. Refit the battery cover, ensuring that the seal is seated correctly.
 5. Refit the key fob the back cover.

Maintaining Your McLaren Washers and Wipers

Replacing the wiper blades

⚠ WARNING: Ensure the ignition is switched off before you replace the wiper blades. The windscreen wipers could be set in motion and injure you.

⚠ WARNING: Replace the wiper blades every twelve months or the windscreen will not be wiped properly. You may not be able to observe the road and traffic conditions as a result and could cause an accident.

Parking the wiper blades

1. Press the STOP/START button once to switch on the accessory mode but DO NOT touch the brake pedal.

2. Pull the wiper control stalk towards you twice, the wipers will move to a winter park position and then to the service park position.

The winter park position locates the wiper arms vertically to aid water run-off and help prevent snow build-up.

The service park position locates the wiper arms in a convenient position for wiper blade replacement.

To Remove the main wiper blade

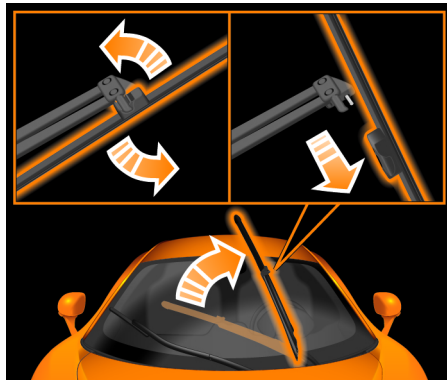

1. Position the wiper blades in the service park position on the windscreen see Parking the wiper blades, page 5.30.

2. Lift the main wiper arm from the screen.
3. Rotate the wiper blade through 90 degrees and remove in the direction of the arrow.

i NOTE: Never open the luggage compartment lid when the wiper arms are positioned away from the windscreen. You could damage the luggage compartment lid and/or the wiper arms.

i NOTE: Do not lower the wiper arms onto the windscreen without the wiper blades fitted.

To install a new main wiper blade

1. Slide the wiper blade onto the wiper arm and rotate 90 degrees.

i NOTE: Ensure the wiper blade is securely fitted in the wiper arm.

2. Lower the wiper arms onto the windscreen.
3. Pull the wiper control stalk towards you once, the wipers will move back to the normal park position.

Maintaining Your McLaren Washers and Wipers

To remove the small wiper blade

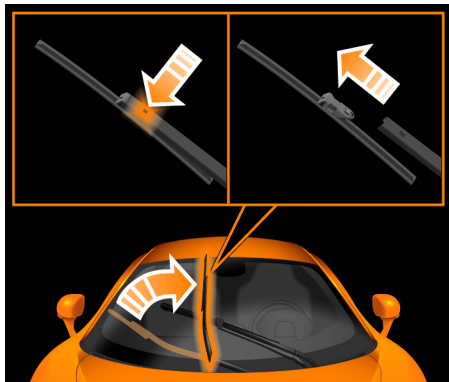

1. Position the wiper blades in the service park position on the windscreen see Parking the wiper blades, page 5.30.
2. Lift the small wiper arm from the screen,
3. Depress the wiper blade clip and slide it out from the arm.

i NOTE: Never open the luggage compartment lid when the wiper arms are positioned away from the windscreen. You could damage the luggage compartment lid and/or the wiper arms.

i NOTE: Do not lower the wiper arms onto the windscreen without the wiper blades fitted.

To install a new small wiper blade

1. Slide the wiper blade onto the wiper arm and ensure that the clip engages in the arm.

i NOTE: Ensure the wiper blade is securely fitted in the wiper arm.

2. Lower the wiper arms onto the windscreen.
3. Pull the wiper control stalk towards you once, the wipers will move back to the normal park position.

Maintaining Your McLaren Wheels and Tyres

Wheels and tyres

 **WARNING:** Have worn tyres replaced in axle pairs and ensure the tyres are fitted as specified. With worn tyres, the driving stability of the vehicle will be adversely affected, especially when driving at high speeds.

Consult your McLaren retailer if you have had new tyres fitted for information on the appropriate bedding in time based on your driving style.

- With new tyres, avoid high speed cornering and excess speed.
- Only have wheels and tyres of the same type and make fitted.
- Never use a tyre which has been punctured and then repaired.
- Only have tyres of the correct size fitted.
- Tyres degrade over time due to the effects of ultraviolet light, extreme temperatures, high loads, and environmental conditions. It is

recommended that tyres are replaced every 6 years, or sooner if required.

McLaren recommends that you only use Pirelli summer or winter tyres, See Wheel and tyre sizes, page 6.13.

These tyres provide the best possible performance in conjunction with the safety systems on your vehicle and have been specifically approved by McLaren.

McLaren cannot accept any responsibility for damage that may result from use of other tyres and wheels. Further information about wheels and tyres can be obtained from your McLaren retailer.

 **WARNING:** Using tyres other than those which have been recommended by McLaren, may contact the body work and adversely affect the handling. This may cause loss of vehicle control, resulting in serious personal injury or death. Noise levels and fuel consumption may also be adversely affected. In addition, when driving with a load or when using snow traction devices, they could cause contact between the bodywork and

axle components. This could result in damage to the tyres or the vehicle.

 **NOTE:** Retreaded tyres must not be used. Do not fit used tyres if you have no information about their previous usage.

 **NOTE:** Modification to the brake system and wheels is not permitted, nor is the use of spacer plates or brake dust shields. Any such modifications will invalidate the vehicle warranty on the area modified.

 **NOTE:** A wheel change must be carried out at your McLaren retailer. The vehicle could be damaged if it is jacked up incorrectly

 **NOTE:** Store tyres in a cool, dry place, preferably in the dark. Protect the tyres from oil, grease and petrol.

Maintaining Your McLaren Wheels and Tyres

Tyre markings

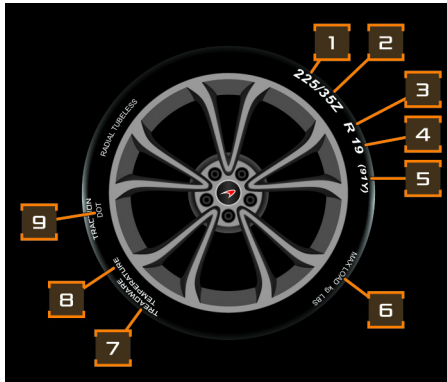

1. Width of tyre in millimetres.
2. Tyre profile given as percentage of tyre width.
3. Indicates that the tyre is radial ply.
4. Indicates the diameter of the wheel rim in inches.
5. The numbers denote load index and the letter indicates the speed rating, 91 indicates a weight of 615 kg (1,350 lbs) and Y indicates speeds over 186 mph (300 kph).
6. Displays the maximum load which can be carried by the tyre.

7. Treadwear grade number. The higher the figure the longer a tyre will last.
8. The alpha character denotes resistance to heat. An 'A' rated tyre offers most heat resistance.
9. Information about the manufacture of the tyre. Contains place and date of manufacture.

Tyres

⚠ WARNING: The tyres must be mounted according to the labelling on the tyre wall. The word 'OUTSIDE' must be on the outer edge of the tyre when it is fitted to the wheel or the stability of the vehicle will be adversely affected, especially at high speeds.

Asymmetric tyres



Asymmetric tyres have a tread pattern that is different from one side of the tread to the other. This combination of tread offers better grip in both wet and dry conditions.

The outer tread features a larger stiffer tread pattern that aids with cornering stability. The inner tread pattern aids stability in wet conditions. A central groove in the tyre aids straight line stability.

⚠ WARNING: Only tyres recommended by McLaren are to be fitted to the vehicle.

Maintaining Your McLaren Wheels and Tyres

⚠ WARNING: The tyres must be mounted according to the labelling on the tyre wall. The benefits of asymmetric tyres will only be available if the tyres are fitted correctly.

Inspecting wheels and tyres

At least every 14 days, check the tyres for cuts, punctures, tears, bumps, deformation and cracks. Check wheels for severe corrosion. Damaged wheels could cause a loss of tyre pressure.

Regularly check the tyre tread depth and the condition of the tread across the whole width of the tyre. Turn the front wheels to full lock in order to inspect the inner tread.



When the tread is worn to 1.6 mm, the wear indicators appear on the surface of the tread pattern, producing a continuous band of rubber across the width of the tyre. Tyres must be replaced as soon as the wear indicator becomes visible, or sooner if legislation dictates replacement at a greater tread depth.

i NOTE: It is recommended that you always have your tyres replaced by your McLaren retailer. Each wheel has a tyre pressure sensor connected to the tyre valve. In order to avoid

damage to the sensor, the tyres must be replaced using the correct procedure.

⚠ WARNING: Tyre grip decreases rapidly on wet or icy roads, particularly when the tread depth is close to the minimum. You could lose control of the vehicle and cause an accident due to the reduced grip of the tyres. Reduce your speed and drive with greater care.

i NOTE: If tread wear is uneven across the tyre, or becomes excessive, the wheel alignment should be checked.

Regularly check the pressure of all your tyres and correct the pressure as necessary, see Tyre pressures, page 5.35.

All wheels must have a valve cap fitted to protect the valve against dirt and moisture.

Driving precautions

When parking your McLaren, ensure that the tyres do not contact the kerb or other obstacles. If it is necessary to drive over kerbs, speed humps or potholes, drive slowly and approach the obstacle at a shallow angle or the tyres could be damaged.

Maintaining Your McLaren Wheels and Tyres

While driving, pay attention to vibrations, noises and unusual handling characteristics, e.g. pulling to one side. This may indicate that the tyres or wheels are damaged. If you experience anything unusual, reduce your speed and stop the vehicle as soon as safety permits to check the tyres and wheels for damage. If you find no signs of damage, have the tyres and wheels inspected at your McLaren retailer.

Tyre pressures

⚠ WARNING: Tyre pressure that is too high or too low has a negative effect on the vehicle's active safety, this could lead to an accident. Frequently check the pressure of all tyres, particularly prior to long trips, and correct the pressure as necessary.

⚠ WARNING: If the pressure in a tyre drops repeatedly, inspect the tyre for foreign objects or signs of punctures, check the valve for air leaks.



For the tyre pressures for various operating conditions, see Tyre pressures, page 6.14. They are also printed on a label attached to the fuel filler flap.

If the vehicle is to be driven at high speeds, the tyre pressure must be checked, and if necessary adjusted.

- i** NOTE: In some markets, the tyre pressure label is attached to the base of the driver's side door aperture.
- i** NOTE: Tyre pressures given for low loads are minimum values which offer optimum ride comfort.

Maintaining Your McLaren Wheels and Tyres

Increased pressures for higher loads will not adversely affect the running of the vehicle, but ride comfort will be impaired.

Check the pressures when the tyres are cold. If it is necessary to check the tyres when they are warm, pressures will be higher. Do not let air out of warm tyres to match the recommended cold tyre pressures.

Driving with tyre pressure that is too high or too low can:

- create a risk of tyre failure with resultant accidents, causing injury or death
- shorten the life of the tyres
- cause increased tyre damage
- have a negative effect on handling characteristics (e.g. by causing aquaplaning)



ENVIRONMENTAL: Check tyre pressures at least every 14 days.

Interchanging wheels



WARNING: Only approved wheels with winter tyres can be fitted to your McLaren as alternatives.

Deflated tyre

Your McLaren is equipped with a can of tyre sealant, which is located in the luggage compartment.

In the event of a puncture, follow the steps below to ensure your safety and the safety of other vehicle occupants and other road users.

Repairing a puncture

1. Stop the vehicle as far away as possible from traffic and on a firm and level surface.
2. If on a public highway, switch on the hazard warning lamps, see Hazard warning lamps, page 1.57.
3. Passengers should exit the vehicle safely and remain well away from the vehicle, the road and any traffic.
4. Apply the parking brake and select neutral.
5. Place the warning triangle at an appropriate distance from the vehicle to warn other traffic of a breakdown, see Warning triangle, page 5.11.

Using the tyre sealant

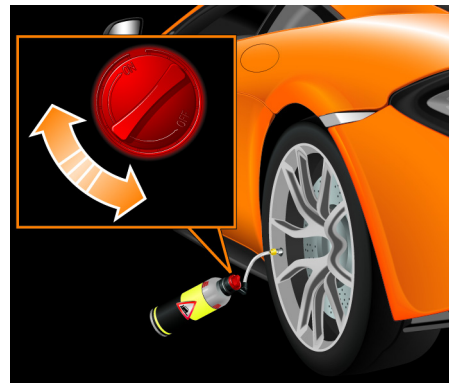

You can use the tyre sealant to seal small punctures, particularly those in the tyre's tread. The tyre sealant can be used at ambient temperatures down to -20°C (-4°F).



WARNING: The tyre sealant is unable to seal punctures if:

- there are cuts or punctures in the tyre greater than 4 mm
- the rims are damaged
- you have driven at very low tyre pressures or with deflated tyres

Contact your McLaren retailer immediately.

Maintaining Your McLaren Wheels and Tyres

Remove the tyre sealant from the luggage compartment and follow the instructions on the container.

 **NOTE:** If possible, locate the cause of the puncture and position the wheel so the puncture is at the lowest point to enable the sealant to be more effective.

Have the punctured tyre replaced as soon as possible.

 **WARNING:** Have punctured tyres replaced. McLaren do not recommend that punctured tyres are repaired.

 **WARNING:** If the tyre sealant comes into contact with your eyes or skin, immediately rinse thoroughly with clean water, change out of clothing which has been in contact with the tyre sealant. If an allergic reaction occurs, contact a doctor immediately.

 **WARNING:** Keep the tyre sealant out of reach of children. If tyre sealant is swallowed, immediately rinse the mouth thoroughly and drink a large amount of water. Do not induce

vomiting. Contact a doctor immediately. Do not inhale tyre sealant fumes.

 **NOTE:** After using tyre sealant, the tyre valve, incorporating the Tyre Pressure Monitoring System sensor, will have to be replaced.

Maintaining Your McLaren

Vehicle Care

Washing your McLaren



ENVIRONMENTAL: Some cleaning products contain chemicals that are hazardous to the environment. Always take precautions to prevent fluids from spilling and never use excessive quantities.

Hand washing your McLaren

Prior to hand washing, lock the vehicle and place the key out of range (at least 3 metres (9.8 feet) or greater distance) to ensure that the doors do not open.

i **NOTE:** Do not wash the vehicle in direct sunlight or if it is hot to the touch, this may cause water marks and streaks.

Do not wash the engine with hose pipe or pressure washer.

Do not use household detergents, these products will discolour painted surfaces and remove protective wax finishes.

1. Pre-rinse the body thoroughly with a hose pipe held at a shallow angle to loosen any dirt and wet the paintwork ready for washing, avoiding direct spray on engine cover vents.
2. Prepare a bucket of warm water and a good quality car shampoo. Refer to the shampoo manufacturer's instructions for dilution ratios.
3. Working from the top of the vehicle down, wash the vehicle, ideally using a lambswool wash mitt rather than a

sponge, use generous quantities of water paying particular attention to areas where dirt can accumulate. Use one wash mitt for the top of the vehicle (roof, luggage compartment lid and areas above the wheel arch line) and a separate mitt for areas below the wheel arch line.

i **NOTE:** Do not clean the wheels with these wash mitts.

i **NOTE:** Do not allow the shampoo to dry, it will leave streaks on the paint work.

4. Tar spots and stubborn grease marks can be removed using white spirit or denatured alcohol. After cleaning, immediately wash the area with soapy water to remove all traces of spirit or alcohol.
5. Once the vehicle is clean, work from the top of the vehicle down and rinse the vehicle thoroughly using a hose pipe held at a shallow angle, avoiding direct spray on engine cover vents.
6. Dry the vehicle using a chamois leather or drying towel.

Maintaining Your McLaren Vehicle Care

i NOTE: In case of signs of water in the engine bay, it is advised to drive the vehicle and warm the engine to operating temperature to dry off any excessive water from the engine.

Washing the wheels

i NOTE: Wash the wheels frequently, do not allow brake dust to become ingrained in the wheel rim finish.

Wash the wheels using warm water, a good quality car shampoo and a wheel brush or wash mitt that is used only on the wheels. Apply polish to non-satin finished wheels to assist in keeping them clean.

i NOTE: Never apply polish to satin finish wheels, this will result in localised glossy patches on the surface of the wheel.

i NOTE: Do not use acid based wheel cleaners as these can damage the wheel rim finish leading to corrosion.

i NOTE: Ensure the brakes are fully dried after the wheels have been cleaned before the vehicle is stored.

Wiper blades and rubber seals

Clean wiper blades and rubber seals using warm water and a good quality car shampoo only. Do not use petroleum or alcohol-based cleaners.

Windscreen, windows and mirrors

Regularly clean all windows inside and out using a window cleaning solution. An automotive glass cleaner is recommended. After washing the vehicle with car shampoo containing wax, clean the outside of the windscreen with glass cleaner. Do not use abrasive cleaning compounds as mirror glass is particularly susceptible to damage.

Underbody cleaning

Salt used on roads to control snow and ice during the winter can collect on the vehicle's underbody, if this is not removed, corrosion can occur. During the winter months, regularly hose the underbody with water paying particular attention to the wheel arches and areas where dirt can accumulate.

Polishing

Occasionally polish the paint work using a good quality polish, following up with a protective wax.

i NOTE: Do not use cutting compound, colour restoration products or polishes containing a harsh abrasive. These can scratch the surface and permanently damage the paint work.

Paint damage and rectification

Regularly inspect the paint work for damage. Any stone chips or deep scratches should be repaired as soon as possible. Contact your McLaren retailer for advice.

Maintaining Your McLaren Vehicle Care

Cleaning the interior



NOTE: Your McLaren retailer will be able to recommend products for cleaning the interior of your vehicle.

Carpet and fabrics

Before cleaning upholstery, always test the cleaning solution on a concealed area. Clean with diluted upholstery cleaner and a clean cloth.

Leather

Before cleaning leather, always test the cleaning solution on a concealed area. Clean with warm water and a non-detergent soap or a proprietary leather cleaner. Dry with a dry, clean, lint-free cloth. Do not use abrasive cleaning products or polish.

Do not polish the upper surfaces of the dashboard. Polished surfaces are reflective and may interfere with the driver's view. Clean with diluted upholstery cleaner, then wipe with a damp cloth.

Carbon Fibre

Before cleaning visible carbon fibre, always test the cleaning solution on a concealed area. Clean with a propriety matt dashboard cleaner. Contact your McLaren retailer for more information. Do not use abrasive cleaning products or polish.

Alcantara®

Dust the material with care. Moisten a soft cloth or a sponge with water, wring it thoroughly and run it over the whole Alcantara® material. Make sure not to wet it excessively; rinse the cloth or sponge and repeat as necessary.

Leave the material to dry overnight.

Once the material has dried, in order to restore the material, brush it delicately with a soft bristle brush.

Seat belts

Extend the belts and clean with warm soapy water only. Do not use any type of detergent or chemical cleaning product. Allow the belts to dry naturally while extended, preferably away from direct sunlight.

Instruments and display screens

Clean the instrument cluster using a damp cloth. Do not use abrasive cleaning products or polish.

Maintaining Your McLaren Vehicle Care

Car cover

A car cover, suitable for use inside a garage, can be purchased from your McLaren retailer.

McLaren recommends that the vehicle is covered if it is to be left in storage for periods over two weeks. Clean the vehicle inside and out, ensuring that it has fully dried, prior to fitting the cover.

i NOTE: Allow the engine to cool before fitting the cover or the hot exhaust pipes could cause damage to the cover.

Maintaining Your McLaren

Raising the Vehicle

Vehicle lifting points

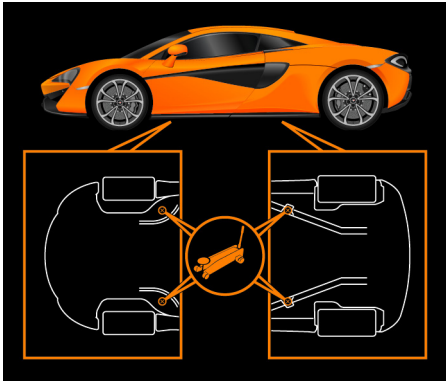

Refer to the illustration, and labels on the vehicle, for correct lifting locations.

Make this information available to any third parties who may be assisting in the recovery of your McLaren.

i NOTE: Lifting the vehicle at any other points will damage the vehicle.

i NOTE: Use a jack with a flat lifting platform and a rubber pad to protect the chassis from surface damage. Do not lift under a body panel.

⚠ **WARNING:** Ensure the vehicle is correctly positioned on a jack or vehicle lift before raising the vehicle to a workable height. Always engage vehicle lift safety locks or use suitable stands to ensure your safety before working under the vehicle.

Maintaining Your McLaren

McLaren Assistance

McLaren Assistance

If your McLaren is immobilised, do not attempt to make your own arrangements for assistance.

Refer to your Service and Warranty Guide, this contains all the information you need.

Replacement battery

If your McLaren has been immobilised due to a fault with the vehicle battery, the battery must only be replaced with a lithium-ion battery of the correct specification.

In the event of a breakdown

In the event of a problem with your vehicle, contact your McLaren retailer. If your McLaren retailer is unavailable, contact the roadside assistance operator who is available 24 hours a day, 7 days a week.

 **NOTE:** The contact details of your roadside assistance operator can be found in your Service and Warranty Guide.

The McLaren retailer or roadside assistance operator will verify your identity and that of your vehicle, as well as determining your exact location.

They will then discuss the problem with you and, with your agreement, determine the best solution.

Maintaining Your McLaren McLaren Assistance

Towing for recovery

Your McLaren is equipped with a front towing eye mounting only.

i NOTE: Do not tow the vehicle, doing so could damage the gearbox. The towing eye must only be used to winch the vehicle onto a trailer or transporter for recovery purposes.

Do not use a rigid bar to tow the vehicle.

Towing eye and mounting

The towing eye is located at the front of the luggage compartment.

1. Remove the cover from the towing eye mounting in the front bumper.

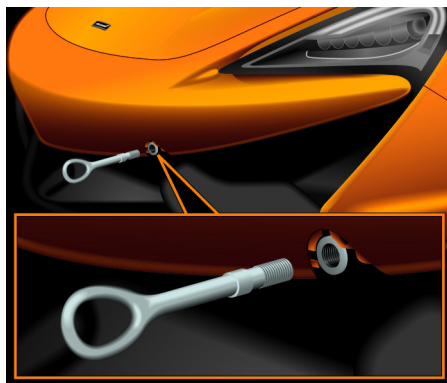

2. Screw the towing eye clockwise into the mounting hole, ensuring that it is screwed in to the full extent of the thread.
- i** NOTE: To avoid damage to the towing eye and the vehicle, it is important to ensure that the towing eye is in full contact with the mating surface of the front structure.
- i** NOTE: A winch cable/strap must be secured to the towing eye only or the vehicle could be damaged.

3. Remove the towing eye, stow it in the luggage compartment and refit the cover to the towing eye mounting as soon as the vehicle has been recovered.

Maintaining Your McLaren Driving Abroad

Driving abroad

McLaren retailers are also at your disposal when you are travelling abroad.

The legal requirements when driving abroad vary from country to country and are constantly changing. Always seek advice from your McLaren retailer regarding what is required to remain legal in the countries in which you are travelling.

In certain countries, only low-octane fuel is available. For further information about fuel grades, see Recommended fuel, page 2.46.

 **NOTE:** The headlamp asymmetric dipped beam is designed to light up the near side of the road more intensely. On your McLaren, the same headlight dipped beam setting applies for driving on either the left-hand or right-hand side of the road.

McLaren

Vehicle Data and Glossary

| | |
|---|-------------|
| Genuine McLaren Parts and Accessories | 6.2 |
| Overview | 6.2 |
| Vehicle Identification..... | 6.3 |
| Vehicle identification number | 6.3 |
| Data | 6.4 |
| Overview | 6.4 |
| Vehicle operating temperatures | 6.4 |
| Engine | 6.5 |
| Maximum speeds in each gear | 6.7 |
| Gear ratios | 6.7 |
| Vehicle dimensions | 6.8 |
| Vehicle weights | 6.9 |
| Wheel and tyre sizes | 6.13 |
| Turning circle | 6.13 |
| Tyre pressures..... | 6.14 |
| Service Products, Fluids and Capacities..... | 6.15 |
| Service products | 6.15 |
| Engine oil specification | 6.15 |
| Fuel..... | 6.15 |
| Coolant..... | 6.16 |
| Power steering fluid | 6.16 |
| Brake fluid | 6.16 |
| Technical Glossary | 6.17 |
| Technical glossary | 6.17 |

Vehicle Data and Glossary

Genuine McLaren Parts and Accessories

Overview

McLaren recommends that you only use genuine McLaren replacement parts and accessories. The use of non-genuine parts could have a detrimental effect on the vehicle's operation and safety. McLaren tests replacement parts and accessories, for reliability, safety and suitability. McLaren accepts no responsibility for the use of non-genuine parts on their vehicles, even if they have been independently approved.

In many countries, replacement parts and accessories are only officially approved for installation if they comply with legal requirements. All genuine McLaren replacement parts and accessories meet these requirements.

Genuine McLaren parts and accessories can be obtained from your McLaren retailer where the parts will be professionally fitted.

Ensure that any accessories are suitable for your McLaren. Accessories which constitute a modification to the vehicle could invalidate the vehicle's warranty. This applies if they:

- change the vehicle type approved in the warranty
- could endanger road users

- adversely affect the vehicle's emissions and noise levels

Always quote the vehicle identification number, you will find this on the vehicle identification plate, and in the bottom left-hand corner of the windscreen.

Vehicle Data and Glossary

Vehicle Identification

Vehicle identification number



The vehicle identification number can be found on the bottom left-hand corner of the windscreen.

The number can also be found engraved on the body behind the right-hand seat, stamped on a plate at the base of the driver's side door aperture and viewed in the Vehicle Info section on the instrument cluster, see Vehicle Identification, page 3.11.

VIN plate

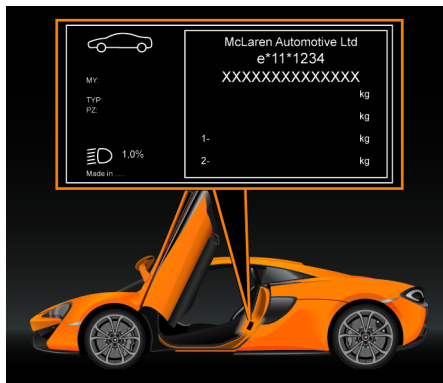

The vehicle identification number plate also contains the following:

- maximum permitted laden weight
- maximum permitted laden weight including trailer
- maximum permitted front axle laden weight
- maximum permitted rear axle laden weight

Vehicle Data and Glossary

Data

Overview

This section contains all the necessary technical data for your vehicle and applies to the vehicle's standard equipment. The data may therefore differ for vehicles with optional equipment. You can obtain further information from your McLaren retailer.

Vehicle operating temperatures

| | |
|---------------------------------------|----------------|
| Minimum ambient operating temperature | -20°C (-4°F) |
| Maximum ambient operating temperature | +50°C (+122°F) |

i NOTE: If the vehicle is used outside the minimum and maximum ambient temperatures, performance degradation may be experienced. McLaren disclaims any liability of the stated engine power not being achieved if the vehicle is being used outside of the stated temperature ranges or being used at altitude.

Vehicle Data and Glossary

Data

Engine

| Engine - 540C Coupe | |
|----------------------------------|-------------------|
| Rated output (kW) @rpm | 397 @ 7,500 |
| Rated output (PS) @rpm | 540 @ 7,500 |
| Rated torque (Nm) @rpm | 540 @ 3,500-6,500 |
| Rated torque (lb-ft) @rpm | 398 @ 3,500-6,500 |
| Number of cylinders | 8 |
| Displacement cm ³ | 3,799 |
| Maximum engine speed (rpm) | 8,500 |
| Power to weight ratio (PS/tonne) | 412 |
| Acceleration (0 to 100 kph) (s) | 3.5 P Zero tyres |
| Acceleration (0 to 60 mph) (s) | 3.4 P Zero tyres |

| Engine - 570S Coupe | |
|----------------------------------|-------------------|
| Rated output (kW) @rpm | 419 @ 7,500 |
| Rated output (PS) @rpm | 570 @ 7,500 |
| Rated torque (Nm) @rpm | 600 @ 5,000-6,500 |
| Rated torque (lb-ft) @rpm | 434 @ 5,000-6,500 |
| Number of cylinders | 8 |
| Displacement cm ³ | 3,799 |
| Maximum engine speed (rpm) | 8,500 |
| Power to weight ratio (PS/tonne) | 434 |
| Acceleration (0 to 100 kph) (s) | 3.2 Corsa tyres |
| Acceleration (0 to 60 mph) (s) | 3.1 Corsa tyres |

| Engine - 570S Spider | |
|----------------------------------|-------------------|
| Rated output (kW) @rpm | 419 @ 7,500 |
| Rated output (PS) @rpm | 570 @ 7,500 |
| Rated torque (Nm) @rpm | 600 @ 5,000-6,500 |
| Rated torque (lb-ft) @rpm | 434 @ 5,000-6,500 |
| Number of cylinders | 8 |
| Displacement cm ³ | 3,799 |
| Maximum engine speed (rpm) | 8,500 |
| Power to weight ratio (PS/tonne) | 409 |
| Acceleration (0 to 100 kph) (s) | 3.2 Corsa tyres |
| Acceleration (0 to 60 mph) (s) | 3.1 Corsa tyres |

Vehicle Data and Glossary

Data

| Engine - 570GT | |
|-------------------------------------|-------------------|
| Rated output (kW) @rpm | 419 @ 7,500 |
| Rated output (PS) @rpm | 570 @ 7,500 |
| Rated torque (Nm) @rpm | 600 @ 5,000-6,500 |
| Rated torque (lb-ft) @rpm | 434 @ 5,000-6,500 |
| Number of cylinders | 8 |
| Displacement cm ³ | 3,799 |
| Maximum engine speed (rpm) | 8,500 |
| Power to weight ratio (PS/tonne) | 424 |
| Acceleration (0 to 100 kph) (s) | 3.4 P Zero tyres |
| Acceleration (0 to 60 mph) (s) | 3.3 P Zero tyres |

Vehicle Data and Glossary

Data

Maximum speeds in each gear

| 540C Coupe | |
|----------------------|-----------|
| 1st gear (mph (kph)) | 48 (77) |
| 2nd gear (mph (kph)) | 73 (117) |
| 3rd gear (mph (kph)) | 101 (162) |
| 4th gear (mph (kph)) | 129 (208) |
| 5th gear (mph (kph)) | 165 (266) |
| 6th gear (mph (kph)) | 199 (320) |
| 7th gear (mph (kph)) | 186 (300) |

| 570S Coupe | |
|----------------------|-----------|
| 1st gear (mph (kph)) | 48 (77) |
| 2nd gear (mph (kph)) | 73 (117) |
| 3rd gear (mph (kph)) | 101 (162) |
| 4th gear (mph (kph)) | 129 (208) |
| 5th gear (mph (kph)) | 165 (266) |
| 6th gear (mph (kph)) | 204 (328) |
| 7th gear (mph (kph)) | 191 (308) |

| 570S Spider | |
|----------------------|-----------|
| 1st gear (mph (kph)) | 48 (77) |
| 2nd gear (mph (kph)) | 73 (117) |
| 3rd gear (mph (kph)) | 101 (162) |
| 4th gear (mph (kph)) | 129 (208) |
| 5th gear (mph (kph)) | 165 (266) |
| 6th gear (mph (kph)) | 204 (328) |
| 7th gear (mph (kph)) | 191 (308) |

| 570GT | |
|----------------------|-----------|
| 1st gear (mph (kph)) | 48 (77) |
| 2nd gear (mph (kph)) | 73 (117) |
| 3rd gear (mph (kph)) | 101 (162) |
| 4th gear (mph (kph)) | 129 (208) |
| 5th gear (mph (kph)) | 165 (266) |
| 6th gear (mph (kph)) | 204 (328) |
| 7th gear (mph (kph)) | 196 (316) |

Gear ratios

| | |
|-------------|---------|
| 1st gear | 3.981:1 |
| 2nd gear | 2.613:1 |
| 3rd gear | 1.905:1 |
| 4th gear | 1.479:1 |
| 5th gear | 1.161:1 |
| 6th gear | 0.906:1 |
| 7th gear | 0.686:1 |
| Final drive | 3.308:1 |

Vehicle Data and Glossary

Data

Vehicle dimensions

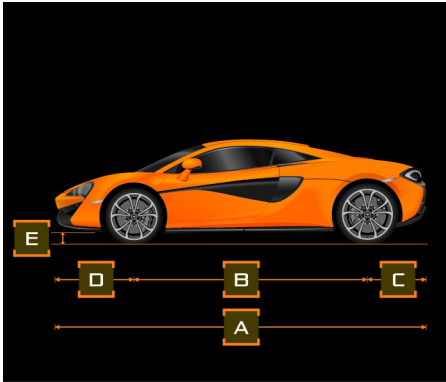

| | | |
|---|------------------|------------------------|
| A | Vehicle length | 4,530 mm (14 ft 11 in) |
| B | Wheelbase | 2,670 mm (8 ft 10 in) |
| C | Rear overhang | 786 mm (2 ft 7 in) |
| D | Front overhang | 1,074 mm (3 ft 7 in) |
| E | Ground clearance | 93 mm (4 in) |

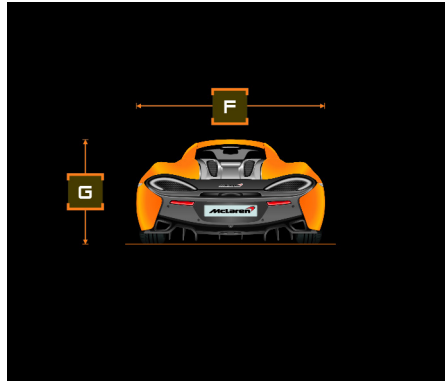

| | | |
|---|---|-----------------------|
| F | Vehicle width (doors closed, including mirrors) | 2,095 mm (6 ft 11 in) |
| G | Vehicle height (doors closed) | 1,202 mm (4 ft) |

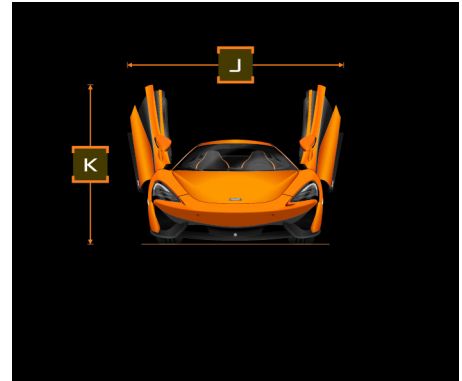

| | | |
|---|--|-----------------------|
| J | Vehicle width (doors open at widest point) | 3,225 mm (10 ft 7 in) |
| K | Vehicle height (doors open) | 1,988 mm (6 ft 7 in) |

i NOTE: All dimensions are approximate.

Vehicle Data and Glossary

Data

Vehicle weights

| Weight - 540C Coupe | |
|---|---------------|
| Dry weight (kg (lbs)) | 1,351 (2,978) |
| Unladen weight (all fluids and 90% fuel) (kg (lbs)) | 1,446 (3,188) |
| Kerb weight (plus 75 kg driver) (kg (lbs)) | 1,526 (3,364) |
| Kerb weight distribution - front axle (kg (lbs)) | 651 (1,435) |
| Kerb weight distribution - rear axle (kg (lbs)) | 875 (1,929) |

| Weight - 540C Coupe | |
|---|---------------|
| Maximum gross vehicle weight (GVW) (kg (lbs)) | 1,694 (3,734) |
| Maximum gross vehicle weight distribution - front axle (kg (lbs)) | 784 (1,728) |
| Maximum gross vehicle weight distribution - rear axle (kg (lbs)) | 910 (2,006) |
| Maximum load - luggage compartment (kg (lbs)) | 50 (110) |

Vehicle Data and Glossary

Data

| Weight - 570S Coupe | |
|---|---------------|
| Dry weight (kg (lbs)) | 1,345 (2,965) |
| Unladen weight (all fluids and 90% fuel) (kg (lbs)) | 1,440 (3,174) |
| Kerb weight (plus 75 kg driver) (kg (lbs)) | 1,520 (3,351) |
| Kerb weight distribution - front axle (kg (lbs)) | 649 (1,431) |
| Kerb weight distribution - rear axle (kg (lbs)) | 871 (1,920) |

| Weight - 570S Coupe | |
|---|---------------|
| Maximum gross vehicle weight (GVW) (kg (lbs)) | 1,687 (3,719) |
| Maximum gross vehicle weight distribution - front axle (kg (lbs)) | 781 (1,722) |
| Maximum gross vehicle weight distribution - rear axle (kg (lbs)) | 906 (1,997) |
| Maximum load - luggage compartment (kg (lbs)) | 50 (110) |

Vehicle Data and Glossary

Data

| Weight - 570S Spider | |
|---|---------------|
| Dry weight (kg (lbs)) | 1,391 (3,067) |
| Unladen weight (all fluids and 90% fuel) (kg (lbs)) | 1,486 (3,276) |
| Kerb weight (plus 75 kg driver) (kg (lbs)) | 1,566 (3,452) |
| Kerb weight distribution - front axle (kg (lbs)) | 671 (1,479) |
| Kerb weight distribution - rear axle (kg (lbs)) | 895 (1,973) |

| Weight - 570S Spider | |
|---|---------------|
| Maximum gross vehicle weight (GVW) (kg (lbs)) | 1,733 (3,821) |
| Maximum gross vehicle weight distribution - front axle (kg (lbs)) | 804 (1,772) |
| Maximum gross vehicle weight distribution - rear axle (kg (lbs)) | 929 (2,048) |
| Maximum load - front luggage compartment (kg (lbs)) | 50 (110) |
| Maximum load - tonneau stowage area (kg (lbs)) | 30 (66) |

Vehicle Data and Glossary

Data

| Weight - 570GT | |
|---|---------------|
| Dry weight (kg (lbs)) | 1,400 (3,087) |
| Unladen weight (all fluids and 90% fuel) (kg (lbs)) | 1,495 (3,296) |
| Kerb weight (plus 75 kg driver) (kg (lbs)) | 1,575 (3,472) |
| Kerb weight distribution - front axle (kg (lbs)) | 675 (1,488) |
| Kerb weight distribution - rear axle (kg (lbs)) | 900 (1,984) |

| Weight - 570GT | |
|---|---------------|
| Maximum gross vehicle weight (GVW) (kg (lbs)) | 1,748 (3,854) |
| Maximum gross vehicle weight distribution - front axle (kg (lbs)) | 812 (1,790) |
| Maximum gross vehicle weight distribution - rear axle (kg (lbs)) | 936 (2,064) |
| Maximum load - front luggage compartment (kg (lbs)) | 50 (110) |
| Maximum load - rear luggage area (kg (lbs)) | 20 (44) |

Vehicle Data and Glossary

Data

Wheel and tyre sizes

Wheel sizes

| | |
|--------------|----------|
| Front wheels | 8J x 19 |
| Rear wheels | 10J x 20 |

Summer tyres

| | |
|----------------------|------------|
| Front tyres | |
| - Pirelli P Zero MC1 | 225/35 R19 |
| - Pirelli Corsa MC1 | 225/35 R19 |

| | |
|----------------------|------------|
| Rear tyres | |
| - Pirelli P Zero MC1 | 285/35 R20 |
| - Pirelli Corsa MC1 | 285/35 R20 |

Winter tyres

| | |
|-----------------------|------------|
| Front tyres | |
| - Pirelli SottoZero 3 | 225/35 R19 |

| | |
|-----------------------|------------|
| Rear tyres | |
| - Pirelli SottoZero 3 | 285/35 R20 |

Turning circle

| | |
|--------------------------------|---------------------|
| Turning circle kerb-to-kerb | 12.4 metres (41 ft) |
|--------------------------------|---------------------|

Vehicle Data and Glossary

Data

Tyre pressures

| Loading condition | Front wheels | | Rear wheels | |
|-------------------------------|--------------|-----|-------------|-----|
| | Bar | Psi | Bar | Psi |
| Normal use | 2.0 | 29 | 2.2 | 32 |
| Speeds over 165 mph (270 kph) | 2.6 | 38 | 2.8 | 41 |

The tyre pressures can also be found on a label on the inside of the fuel filler flap.



i NOTE: In some markets, the tyre pressure label is attached to the base of the driver's side door aperture.

Vehicle Data and Glossary

Service Products, Fluids and Capacities

Service products

Service products are fuel, engine oil, coolant and brake fluid. McLaren recommends that you only use products tested and approved for McLaren. Damage resulting from using non-approved service products is not covered by the liability for material defects.

 **WARNING: When handling, storing and disposing of any service products, please observe the relevant regulations. Failure to do so could endanger people and the environment. Do not allow service products to come into direct contact with your eyes or open wounds. Contact a doctor immediately if any service product is swallowed.**

 **ENVIRONMENTAL:** Dispose of service products in an environmentally responsible manner.

Engine oil specification

| | |
|---------------------|------------|
| Engine oil capacity | 9.0 litres |
|---------------------|------------|

 **NOTE:** McLaren recommends only OW-40 engine oil.

You may obtain further information from your McLaren retailer.

 **NOTE:** Do not use any lubricant additives. These could lead to increased wear and damage to the mechanical assemblies. Damage caused by additives, which are not approved, is not covered by the McLaren warranty.

Fuel

 **WARNING: Fuel is highly flammable. Fire, naked flames and smoking are prohibited when handling fuels.**

Switch off the engine before refuelling.

 **WARNING: Do not allow fuel to come into contact with skin or clothing.**

Allowing fuels to come into direct contact with your skin or inhaling fuel vapours is damaging to your health.

For more information about fuel, see Recommended fuel, page 2.46.

Fuel tank

| | |
|--|-----------------------------|
| Total capacity | 72 litres (15.8 UK gal.) |
| Capacity remaining when low level lamp illuminates | 11 litres (2.4 UK gal.) |

Vehicle Data and Glossary

Service Products, Fluids and Capacities

Coolant

| | |
|--|------------------------------|
| Cooling system capacity | 23.4 litres (5.2 UK gal.) |
| Antifreeze quantity for protection to -20°C (-4°F) | 13.0 litres (2.9 UK gal.) |

The coolant is a mixture of water, antifreeze and corrosion inhibitor. It performs the following functions in the cooling system:

- antifreeze protection
- increased efficiency of the cooling system
- offers anti-corrosion protection

 **NOTE:** Use antifreeze in all climates, all year round. If coolant is not used, the cooling system will not be sufficiently protected from corrosion and the cooling system efficiency will be reduced.

 **NOTE:** To prevent damage to the engine, only top up with a pre-mixed coolant that provides the desired level of antifreeze protection.

If antifreeze/corrosion inhibitor is present in the correct concentration, the boiling point of the coolant will be around 130°C (266°F). The antifreeze and corrosion inhibitor concentration in the cooling system should be approximately 50% ±5%. This will protect the cooling system against freezing in temperatures of -40°C (-40°F).

The antifreeze and corrosion inhibitor concentration in the cooling system should not exceed 55%, which provides antifreeze protection down to -45°C (-49°F), as a higher concentration will not dissipate heat as effectively.

If the vehicle is losing coolant, do not drive your vehicle and contact your McLaren retailer.

Power steering fluid

Only use Pentosin CHF202 power steering fluid.

Brake fluid

Only use Pentosin DoT 5.1 Brake fluid.

Over time, the brake fluid absorbs moisture from the air, this reduces its boiling point.

 **WARNING:** If the boiling point of the brake fluid is reduced too much, vapour pockets may form in the brake system when the brakes are applied hard (e.g. when driving downhill or track driving) impairing the braking efficiency. Therefore, the brake fluid must be replaced at the recommended service intervals.

Vehicle Data and Glossary

Technical Glossary

Technical glossary

Active dynamics control

A system that allows the driver to change the handling and performance characteristics of the vehicle.

Anti-lock Braking System

The anti-lock braking system prevents the wheels from locking when you brake. This allows the vehicle to be steered during braking manoeuvres.

Automatic driver recognition cards

A card which must be on the person entering the vehicle or the Tracker system signals that the vehicle is being moved without authorisation.

Brake assist system

Brake assist system operates in emergency braking situations. If you depress the brake pedal quickly, Brake assist system automatically increases the force being applied to the brakes and thus shortens the stopping distance.

Brake disc wiping

Brake disc wiping operates when the windscreen wipers are switched on. It prevents moisture build up on the brake discs during periods of heavy rain, by applying the brakes momentarily, so that the pads touch the discs.

Brake steer

Brake steer offers the benefits of a torque vectoring differential, but is integrated into the braking system reducing weight and providing excellent speed of response.

If the system detects that the vehicle is starting to understeer through a corner, the inside rear brake is gently applied. This helps to increase the yaw rate of the vehicle, making the vehicle feel more resistant to understeer. The lateral 'g' force is also increased giving better handling characteristics.

If the driver uses too much throttle exiting a corner, the inside rear wheel increases speed, which without brake steer could cause the vehicle to become unstable. In this situation, brake steer will again gently apply the brake on the inside rear wheel, thereby restoring traction and stability.

Cylinder cut

When calling for an upshift at moderate engine speeds under hard acceleration within Sport powertrain mode, the number of firing engine cylinders are cut to rapidly decrease the engine torque and engine speed allowing faster upshifts to be achieved. This will make the upshift more audibly noticeable than a normal upshift. This also occurs in Track powertrain mode, but at high engine speeds it is replaced by inertia push. See Inertia push, page 6.18.

Electronic brake pre-fill

If the accelerator pedal is suddenly released, the electronic brake pre-fill function immediately brings the brake pads into contact with the discs, making for more rapid braking.

Electronic Stability Control

ESC monitors driving stability and traction between the tyres and the road surface.

Global Positioning System

By means of the appropriate receivers, satellite signals supply information on the geographical position of the vehicle. These

signals are compared with a digital map and used both to determine the position of the vehicle and for its route guidance.

Handling control

The handling control switch affects the following vehicle characteristics:

- Adaptive damping
- ESC settings

Hill hold control

Hill hold control prevents roll-back on hill starts. The brake system automatically applies the brakes until the accelerator is pressed.

Inertia push

Within Track powertrain mode when calling for an upshift at high engine speeds under hard acceleration, inertia push delivers greater acceleration. Under normal driving conditions, outside of inertia push when maximum performance is not called for, the engine and transmission speeds are aligned for a smooth seamless upshift. However, with inertia push, the clutch holding the next gear is engaged with greater force and the engine speed is not allowed to decrease fully, therefore utilising the inertia of its

internal rotating masses. This in turn provides a torque impulse as the gear is engaged aiding acceleration and maximising performance.

Keyless Entry

Keyless Entry allows the driver to unlock the vehicle and disarm the alarm by simply opening the door when the key is within 1.5 metres (5 feet) of the door sensors.

Launch control

Launch control is designed to give the maximum acceleration performance from a standing start.

McLaren Track Telemetry

The McLaren Track Telemetry system provides timing data recording and graphical visualisation for track use, e.g. circuits and hill-climbs.

Parking sensors

The parking sensor system comprises four ultrasonic sensors in the front bumper, four ultrasonic sensors in the rear bumper and two sounders. When the parking sensors detect an obstruction while manoeuvring, the sounders provide an audible warning.

Performance Shift Cue (PSC)

PSC is an audible shift indicator, which will sound to indicate that an upshift is required to maintain optimum performance.

Rear View Camera

The Rear View Camera (RVC) is mounted in the centre of the rear grille. The live video feed is displayed on the instrument cluster when the function is active.

Seamless Shift Gearbox

The seamless shift gearbox is a 7 speed, dual clutch gearbox. Gear changes can be fully automatic or driver controlled. The gear changes are almost instantaneous. It is this coupled with uninterrupted torque delivery from the engine which provides the relentless acceleration.

Supplementary Restraint System

System comprises a number of air bags which are automatically deployed in an accident to provide additional occupant protection.

Vehicle Data and Glossary

Technical Glossary

Tyre Pressure Monitoring System

Tyre Pressure Monitoring System constantly checks the pressure and temperature in all four tyres. It warns if the pressure drops or the temperature rises in one or more of the tyres.

Vehicle Identification Number

The vehicle identification number is a unique 17 digit number which provides information about your vehicle, as well as when and where it was built.

Typical vehicle identification number =
SBM13AAA9GW005000

McLaren

Index

| | |
|---|------|
| A | |
| Accelerator pedal position | 2.18 |
| Accessories | 6.2 |
| Active dynamics panel | 2.21 |
| active button | 2.21 |
| handling control | 2.22 |
| launch control | 2.26 |
| powertrain control | 2.24 |
| Active speed limiter | 2.41 |
| setting an upper speed limit | 2.41 |
| Air bags | 1.43 |
| child passengers | 1.47 |
| deployment | 1.46 |
| front air bags | 1.44 |
| occupant classification system | 1.45 |
| Out Of Position (OOP) testing | 1.46 |
| replacement | 1.43 |
| side head air bags | 1.44 |
| system modification | 1.44 |
| Air distribution - climate control | 4.9 |
| Air recirculation mode - climate control .. | 4.8 |
| Air vents | 4.9 |
| Alarm | 1.28 |
| arming | 1.28 |
| disarming | 1.28 |
| panic | 1.58 |
| Anti-lock Braking System | 2.28 |
| Anti-trap protection - windows | 4.3 |
| Auto alarm | 3.23 |
| Auto door lock | 3.23 |
| Auto fold mirrors | 3.23 |
| Automatic light control | 1.54 |
| Automatic locking | 1.11 |
| Automatic mode - climate control | 4.5 |
| Automatic mode - transmission | 2.18 |
| Automatic wipe | 1.59 |
| B | |
| Backlight | 1.21 |
| closing | 1.22 |
| opening | 1.21 |
| operation | 1.21 |
| Battery fuse box | 5.21 |
| fuses | 5.21 |
| Battery replacement - key fob | 5.29 |
| Battery safety | 5.14 |
| Battery status | 3.10 |
| Belts - seat | 1.41 |
| Blower speed - climate control | 4.8 |
| Boost starting | 5.15 |
| Brake assist system | 2.29 |
| Brake disc wiping | 2.29 |
| Brake fluid | 6.16 |
| topping up | 5.9 |
| Brake pedal | 2.9 |
| Brakes | |
| Anti-lock Braking System | 2.28 |
| Anti-lock Braking System warning light | 2.29 |
| bedding-in | 2.42 |
| brake assist system | 2.29 |
| brake disc wiping | 2.29 |
| brake steer | 2.30 |
| electronic brake pre-fill | 2.30 |
| foot | 2.9 |
| hill hold control | 2.30 |
| parking | 2.8 |
| pedal | 2.9 |
| warning light | 2.9 |
| Brake-steer | 2.30 |
| Breakdown | 5.43 |
| Bulb replacement | 5.24 |
| Bulkhead stowage net | 4.13 |
| C | |
| Calibration - climate control | 4.11 |
| Camera | 2.16 |
| rear view | 2.16 |
| Capacities | 6.15 |
| cooling system | 6.16 |
| engine oil | 6.15 |
| fuel tank | 6.15 |
| Car cover | 5.41 |
| Catalytic converter | 2.14 |

Index

| | |
|---------------------------------------|------|
| high temperature | 2.14 |
| Centre console stowage compartment . | 4.15 |
| Changing wheels | 5.36 |
| Checking engine oil | 5.2 |
| Child passengers | 1.47 |
| Child restraint system | 1.48 |
| KISI child seat function | 1.49 |
| Cleaning | 5.38 |
| exterior | 5.38 |
| instruments and display screens | 5.40 |
| interior | 5.40 |
| wheels | 5.39 |
| Climate control | 4.4 |
| air conditioning controls | 4.5 |
| air distribution | 4.9 |
| air recirculation mode | 4.8 |
| air vents | 4.9 |
| automatic mode | 4.5 |
| blower speed | 4.8 |
| calibration | 4.11 |
| controls | 4.4 |
| demisting | 4.6 |
| heated mirrors | 4.11 |
| heated seats | 4.10 |
| manual mode | 4.6 |
| MONO mode | 4.6 |
| switching on/off | 4.6 |
| temperature | 4.7 |
| Clock | 3.7 |

| | |
|---------------------------------|------------|
| Closing the backlight | 1.22 |
| Closing the luggage compartment | 1.16, 1.18 |
| Closing the roof | 1.20 |
| Closing the service cover | 1.13, 1.14 |
| Closing the windows | 4.2 |
| Coolant | 6.16 |
| topping up | 5.6 |
| Copyright | 3 |
| Cover - service | 1.12, 1.13 |
| closing | 1.13, 1.14 |
| opening | 1.12, 1.13 |
| Cruise control | 2.37 |
| cancelling | 2.38 |
| decreasing speed | 2.39 |
| increasing speed | 2.39 |
| resuming speed | 2.40 |
| setting | 2.37 |
| Cup holders | 4.17 |

D

| | |
|------------------------------------|------|
| Data | 6.4 |
| Daytime running lamps | 1.56 |
| Defaults - vehicle settings | 3.26 |
| Defrosting - climate control | 4.6 |
| Demisting - climate control | 4.6 |
| Deployment - air bags | 1.46 |
| Dimensions | 6.8 |
| Dipped beam headlamps | 1.55 |

| | |
|--|------|
| Direction indicators | 1.57 |
| Discharged battery | 1.6 |
| Discharged key fob battery | 5.29 |
| starting the engine | 5.27 |
| unlocking | 5.25 |
| Display | 3.32 |
| defaults | 3.26 |
| Electronic Stability Control display | 3.35 |
| fuel level | 3.37 |
| fuel range | 3.37 |
| gear position indicator | 3.35 |
| handling and powertrain display | 3.35 |
| home screen | 3.7 |
| instruments cluster | 3.4 |
| messages | 3.28 |
| messages - Spider only | 3.30 |
| normal mode | 3.32 |
| nose lift | 3.12 |
| oil temperature | 3.36 |
| settings | 3.16 |
| sport mode | 3.33 |
| track mode | 3.34 |
| trip computer | 3.8 |
| vehicle info | 3.9 |
| water temperature | 3.36 |
| Display messages | 3.28 |
| Spider only | 3.30 |
| Display screen cleaning | 5.40 |
| Display set-up | 3.16 |

Index

| | | | | | |
|---|-----------|--|------|----------------------------------|------|
| external lighting | 3.18 | Dynamic ESC modes | 2.32 | Engine oil | 5.2 |
| internal lighting | 3.19 | | | capacity | 6.15 |
| language | 3.17 | E | | checking | 5.2 |
| lighting | 3.18 | <hr/> | | level warnings | 5.2 |
| time & date | 3.17 | Eco Start-Stop System | 2.11 | specification | 6.15 |
| units | 3.16 | Economical driving | 2.13 | temperature warnings | 5.5 |
| Door mirror heating | 1.51 | Electric seats | 1.33 | topping up | 5.3 |
| Door stowage compartments | 4.16 | backrest rake adjustment | 1.34 | usage | 5.2 |
| Door unlock | 3.23 | forward and rearward adjustment | 1.33 | Entry lighting | 4.12 |
| Doors | 1.4 | height adjustment | 1.34 | Equipment | 5.11 |
| automatic locking | 1.11 | lumbar adjustment | 1.35 | luggage compartment | 5.11 |
| closing | 1.11 | Electric seats and mirror memory | 1.35 | Error messages | 3.9 |
| locking | 1.7 | Electrical status | 2.2 | Exhaust | 2.14 |
| locking and unlocking from inside | 1.9, 1.10 | Electrochromatic Panoramic Roof | 4.13 | temperature monitoring | 2.14 |
| manual opening from inside | 5.27 | Electronic brake pre-fill | 2.30 | Exit lighting | 4.13 |
| opening from inside | 1.10 | Electronic Stability Control | 2.31 | Exterior lighting | 1.52 |
| opening from inside - discharged | | deactivating | 2.31 | Exterior mirrors | 1.50 |
| battery | 5.27 | dynamic modes | 2.32 | heating | 1.51 |
| opening from outside | 1.6 | reactivating | 2.33 | memory | 1.35 |
| opening from outside - discharged | | Emergency fuel filling funnel | 5.13 | mirror automatic fold | 1.51 |
| battery | 5.25 | Engine | 2.10 | mirror fold | 1.51 |
| stowage compartment | 4.16 | Eco Start-Stop System | 2.11 | reverse dip | 1.51 |
| Drink holders | 4.17 | immobiliser | 1.28 | External lighting settings | 3.18 |
| Driving abroad | 5.45 | power output | 6.5 | Extinguisher | 5.13 |
| Driving away | 2.12 | running in | 2.42 | Eye - towing | 5.13 |
| Driving in winter | 2.47 | starting | 2.10 | | |
| Driving precautions | 5.34 | stopping | 2.10 | F | |
| Driving safety systems | 2.28 | technical data | 6.5 | <hr/> | |
| | | warning light | 2.13 | Features | 4.12 |

Index

| | |
|-----------------------------------|------|
| 12 V socket | 4.18 |
| cup holders | 4.17 |
| entry lighting | 4.12 |
| exit lighting | 4.13 |
| interior lighting | 4.12 |
| panoramic roof | 4.13 |
| stowage compartments | 4.15 |
| stowage net | 4.13 |
| sun visors | 4.18 |
| USB sockets | 4.19 |
| Filling with fuel | 2.44 |
| Fire extinguisher | 5.13 |
| First aid kit | 5.12 |
| Fluid - brake | 6.16 |
| topping up | 5.9 |
| Fluid - power steering | 6.16 |
| topping up | 5.8 |
| Foot brake | 2.9 |
| Force limiters - seat belts | 1.42 |
| Front air bags | 1.44 |
| Front luggage compartment | 1.15 |
| unlocking and opening | 1.15 |
| Fuel | 2.44 |
| funnel | 5.13 |
| quality | 2.46 |
| safety | 6.15 |
| tank | 6.15 |
| Fuel level display | 3.37 |
| Fuel range display | 3.37 |

| | |
|--------------------------|------|
| Funnel - fuel | 5.13 |
| Fuse box | |
| battery | 5.21 |
| main | 5.18 |
| secondary | 5.20 |
| Fuses | 5.18 |
| battery fuse box | 5.21 |
| main fuse box | 5.18 |
| replacement | 5.18 |
| secondary fuse box | 5.20 |

G

| | |
|---|------|
| Gear position indicator | 3.35 |
| Gear positions | 2.6 |
| Gear ratios | 6.7 |
| Gear shift indicator | 2.13 |
| Gearbox | 2.17 |
| gear positions | 2.17 |
| gearshift paddles | 2.20 |
| kickdown | 2.18 |
| manual/automatic mode | 2.18 |
| oil topping up | 5.5 |
| Genuine McLaren parts and accessories | 6.2 |
| Glossary - technical | 6.17 |
| Glove box | 4.15 |
| Ground clearance | 6 |

H

| | |
|----------------------------|------------|
| Handling control | 2.22 |
| Hazard warning lamps | 1.57 |
| Headlamps | 1.55 |
| flash | 1.55 |
| main beam | 1.55 |
| Heated mirrors | 1.51, 4.11 |
| Heated seats | 1.37, 4.10 |
| Hill hold control | 2.30 |
| Horn | 1.40 |

I

| | |
|--|------|
| Identification number - vehicle | 6.3 |
| Ignition - switching on | 2.3 |
| Immobiliser | 1.28 |
| In gear speeds | 6.7 |
| Increasing nose ground clearance | 1.61 |
| Increasing nose ride height | 1.61 |
| Individual unlock settings | 1.9 |
| Inspecting tyres | 5.34 |
| Inspecting wheels | 5.34 |
| Installing luggage bags | 1.25 |
| Installing stowage bags | 1.26 |
| Instrument cluster display | 3.4 |
| Instruments | 3.32 |
| central display overview | 2.4 |
| cleaning | 5.40 |

Index

| | | | | | |
|---------------------------------------|------|----------------------------------|------|--------------------------------|------------|
| defaults | 3.26 | courtesy lighting | 4.12 | Lifting points - vehicle | 5.42 |
| display | 3.32 | Interior mirror | 1.50 | Light switch | 1.54 |
| display messages | 3.28 | Interior motion sensor | 1.30 | Lighting | 1.52 |
| display messages - Spider only | 3.30 | Internal lighting settings | 3.19 | automatic control | 1.54 |
| display window | 3.32 | Introduction | 2 | courtesy lighting | 4.12 |
| Electronic Stability Control mode | | | | day time running lamps | 1.56 |
| display | 3.35 | | | dipped beam | 1.55 |
| fuel level display | 3.37 | J | | direction indicators | 1.57 |
| fuel range display | 3.37 | Jacking the vehicle | 5.42 | exterior | 1.52 |
| gear position indicator | 3.35 | Journey trip | 3.7 | hazard warning lamps | 1.57 |
| handling and powertrain display | 3.35 | Jump starting | 5.15 | headlamp flash | 1.55 |
| home screen | 3.7 | | | interior | 4.12 |
| left-hand display overview | 2.5 | K | | main beam | 1.55 |
| normal mode | 3.32 | Key fob | 1.5 | parking lights | 1.58 |
| nose lift | 3.12 | battery replacement | 5.29 | rear fog lamp | 1.56 |
| oil temperature display | 3.36 | discharged battery | 1.6 | sidelamps | 1.55 |
| overview | 3.2 | entry | 1.5 | switch | 1.54 |
| right-hand display overview | 2.5 | stowing | 1.6 | Lighting settings | 3.18 |
| settings | 3.16 | Keyless entry | 1.4 | Limphome | 2.13 |
| speedometer | 3.3 | Kickdown | 2.18 | Locking | 1.7 |
| sport mode | 3.33 | Kit - first aid | 5.12 | automatic | 1.11 |
| tachometer | 3.2 | Kit - tyre repair | 5.36 | from inside | 1.9, 1.10 |
| track mode | 3.34 | | | from outside | 1.7 |
| trip computer | 3.8 | | | mislock | 1.8 |
| vehicle info | 3.9 | L | | Luggage compartment | |
| water temperature display | 3.36 | Lamps - side | 1.55 | closing | 1.16, 1.18 |
| Interchanging wheels | 5.36 | Language settings | 3.17 | equipment | 5.11 |
| Interior accessory power socket | 4.18 | Launch control | 2.26 | front | 1.15 |
| Interior lighting | 4.12 | | | manual opening | 5.28 |

Index

opening - discharged battery5.28
rear1.17

M

Main beam1.55
Main fuse box 5.18
 fuses 5.18
Main instruments overview2.4
Manual mode - climate control 4.6
Manual mode - transmission 2.18
Manual seats1.31
 backrest rake adjustment1.32
 forward and rearward adjustment 1.31
 height adjustment1.32
Manual unlocking 5.25
McLaren Assistance5.43
McLaren parts and accessories6.2
McLaren track telemetry
 USB sockets 4.19
Media USB sockets 4.19
Mirror 1.50
 automatic exterior mirror fold1.51
 exterior 1.50
 exterior mirror fold1.51
 heating1.51, 4.11
 interior 1.50
 memory1.35
 reverse dip1.51

Mislock1.8
MONO mode - climate control4.6
Motion sensor - interior1.30
MSO Defined Electrochromatic
Panoramic Roof4.13

N

Navigation 3.23
Nose lift1.61, 3.12
 accessing3.12
 lower3.14
 operation1.61
 raise3.13

O

Odometer 3.7
Oil - engine5.2
 capacity6.15
 checking 5.2
 level 5.2
 level warnings5.2
 specification6.15
 status3.10
 temperature display3.36
 temperature warnings5.5
 top up5.3
Oil - gearbox5.5

Opening a door1.6, 1.10
 from inside 1.10
 from outside1.6
Opening and closing1.4
Opening and closing the tonneau cover 1.23
Opening and closing the vents 4.9
Opening the backlight 1.21
Opening the roof1.19
Opening the service cover1.12, 1.13
Opening the windows 4.2
Operating temperatures - vehicle6.4
Outside temperature display 3.7
Owner documentation4.17

P

Panic alarm1.58
Panoramic Roof4.13
Parking brake 2.8
Parking days 2.3
Parking lights1.58
Parking sensors2.14
Parts 6.2
Passenger's footwell stowage net4.14
Passengers - child1.47
Performance shift cue3.22
Power output 6.5
 engine 6.5
Power steering fluid6.16

Index

| | |
|-----------------------------|------------|
| topping up | 5.8 |
| Powertrain control | 2.24 |
| Precautions - driving | 5.34 |
| Pressures - tyre | 5.35, 6.14 |
| Products - service | 6.15 |
| Puncture repair kit | 5.36 |

R

| | |
|--|------|
| Racing seats | 1.32 |
| adjustment | 1.32 |
| Rain sensor | 1.59 |
| Ratios - gear | 6.7 |
| Reading lights | 4.12 |
| Rear fog lamp | 1.56 |
| Rear luggage compartment | 1.17 |
| unlocking and opening | 1.17 |
| Rear view camera | 2.16 |
| Recirculation mode - climate control | 4.8 |
| Recommended fuel quality | 2.46 |
| Recovery of your vehicle | 5.44 |
| Refuelling | 2.44 |
| Removing and storing stowage bags | 1.27 |
| Replacement battery | 5.43 |
| Replacing | |
| bulbs | 5.24 |
| fuse | 5.18 |
| key fob battery | 5.29 |
| vehicle battery | 5.43 |

| | |
|-----------------------------------|------|
| wiper blade | 5.30 |
| Restraint system | 1.43 |
| child | 1.48 |
| KISI child seat function | 1.49 |
| supplementary | 1.43 |
| Retractable roof | 1.18 |
| safe operating temperatures | 1.19 |
| Rev counter | 3.2 |
| Reverse mirror dip | 3.24 |
| Reverse select tone | 3.22 |
| Road speed limit | 3.23 |
| Roof | 1.18 |
| closing | 1.20 |
| opening | 1.19 |
| Running in | 2.42 |

S

| | |
|--------------------------------------|------|
| Safety | 1.41 |
| air bag system modification | 1.44 |
| air bags | 1.43 |
| air bags Out Of Position (OOP) | 1.46 |
| battery | 5.14 |
| fuel | 6.15 |
| mirrors | 1.50 |
| replacement of air bags | 1.43 |
| seat belts | 1.41 |
| seats | 1.31 |
| Sealant - tyre | 5.12 |

| | |
|--|------------|
| Seamless Shift Gearbox | 2.17 |
| gear positions | 2.17 |
| gearshift paddles | 2.20 |
| kickdown | 2.18 |
| manual/automatic mode | 2.18 |
| Seat belt warning light | 1.43 |
| Seat belts | 1.41 |
| force limiters | 1.42 |
| safety | 1.41 |
| tensioners | 1.42 |
| wearing | 1.42 |
| Seat stowage pocket | 4.17, 4.18 |
| Seats | 1.31 |
| backrest - electric rake adjustment | 1.34 |
| backrest - manual rake adjustment | 1.32 |
| electric adjustment | 1.33 |
| electric backrest rake adjustment | 1.34 |
| electric forward and rearward adjustment | 1.33 |
| electric height adjustment | 1.34 |
| electric seat and mirror memory | 1.35 |
| electric seat lumbar adjustment | 1.35 |
| heating | 1.37, 4.10 |
| manual adjustment | 1.31 |
| manual backrest rake adjustment | 1.32 |
| manual forward and rearward adjustment | 1.31 |
| manual height adjustment | 1.32 |

Index

| | |
|---|------------|
| racing seat adjustment | 1.32 |
| safety | 1.31 |
| stowage pocket | 4.17, 4.18 |
| Secondary fuse box | 5.20 |
| fuses | 5.20 |
| Sensors | |
| interior motion | 1.30 |
| parking | 2.14 |
| Service and Warranty | 4.17 |
| Service cover | 1.12, 1.13 |
| closing | 1.13, 1.14 |
| opening | 1.12, 1.13 |
| Service interval | 3.9 |
| Service products | 6.15 |
| Setting up warning triangle | 5.12 |
| Settings | 3.16 |
| display set-up | 3.16 |
| external lighting | 3.18 |
| internal lighting | 3.19 |
| language | 3.17 |
| lighting | 3.18 |
| time & date | 3.17 |
| units | 3.16 |
| vehicle | 3.19 |
| Settings - individual unlock | 1.9 |
| Shift lights | 3.2 |
| Side head air bags | 1.44 |
| Sidelamps | 1.55 |
| Silent lock | 3.23 |
| Snow socks | 2.47 |
| Specification - engine oil | 6.15 |
| Speedometer | 3.3 |
| Speeds - in gear | 6.7 |
| START/STOP button | 2.3 |
| Starting and driving | 2.2 |
| foot brake | 2.9 |
| gear positions | 2.6 |
| gearshift paddles | 2.7 |
| instruments and warning lights | 2.4 |
| main instruments | 2.4 |
| parking brake | 2.8 |
| starting the engine | 2.10 |
| switching on the ignition | 2.3 |
| warning lights | 2.4 |
| Starting the engine | 2.10 |
| discharged key fob battery | 5.27 |
| Steering column | 1.38 |
| electrical adjustment | 1.38 |
| manual adjustment | 1.38 |
| Steering wheel | 1.38 |
| electrical adjustment | 1.38 |
| horn | 1.40 |
| manual adjustment | 1.38 |
| Stopping the engine | 2.10 |
| Stowage bags | 1.25 |
| installing | 1.26 |
| removing and storing | 1.27 |
| Stowage compartments | 4.15 |
| centre console | 4.15 |
| door | 4.16 |
| glove box | 4.15 |
| seat | 4.17, 4.18 |
| Stowage luggage | 1.25 |
| Stowage net | 4.13 |
| Stowing the key fob | 1.6 |
| Summer tyres | 6.13 |
| Sun visors | 4.18 |
| Supplementary Restraint System | 1.43 |
| Switch - lighting | 1.54 |
| Switching air conditioning on/off | 4.6 |
| Switching on the ignition | 2.3 |
| Symbols | 5 |
| T | |
| Tachometer | 3.2 |
| Technical data | 6.4 |
| engine | 6.5 |
| gear ratios | 6.7 |
| speeds - in gear | 6.7 |
| turning circle | 6.13 |
| tyre pressures | 6.14 |
| vehicle dimensions | 6.8 |
| vehicle operating temperatures | 6.4 |
| vehicle weights | 6.9 |
| wheel and tyre sizes | 6.13 |
| Technical glossary | 6.17 |

Index

| | | | | | |
|-------------------------------------|------|--------------------------------------|------------|-------------------------------------|------|
| Temperature - climate control | 4.7 | markings | 5.33 | Vehicle dimensions | 6.8 |
| Temperature display | 3.7 | monitoring system | 2.34 | Vehicle electrical status | 2.2 |
| Tensioners - seat belt | 1.42 | pressure monitoring | 2.34 | Vehicle identification | 3.11 |
| Time & date settings | 3.17 | pressures | 5.35, 6.14 | Vehicle identification number | 6.3 |
| Tonneau cover | 1.23 | repair kit | 5.36 | Vehicle info | 3.9 |
| opening and closing | 1.23 | sealant | 5.12 | battery status | 3.10 |
| Topping up | 5.2 | summer | 6.13 | error messages | 3.9 |
| brake fluid | 5.9 | temperature monitoring | 2.35 | oil status | 3.10 |
| coolant | 5.6 | winter | 6.13 | service interval | 3.9 |
| engine oil | 5.3 | | | tyre monitoring | 3.10 |
| gearbox oil | 5.5 | | | vehicle identification | 3.11 |
| power steering fluid | 5.8 | | | Vehicle lifting points | 5.42 |
| windscreen washers | 5.10 | | | Vehicle settings | 3.19 |
| Tow-away protection | 1.29 | U | | auto alarm | 3.23 |
| Towing | 5.44 | Units | 3.16 | auto door lock | 3.23 |
| eye | 5.13 | Unlocking - discharged battery | 5.25 | auto fold mirrors | 3.23 |
| Track driving | 6 | Unlocking and opening the front | | defaults | 3.26 |
| Track use | 2.43 | luggage compartment | 1.15 | door unlock | 3.23 |
| Traction control system | 2.31 | Unlocking and opening the rear | | navigation | 3.23 |
| Triangle - warning | 5.11 | luggage compartment | 1.17 | reverse mirror dip | 3.24 |
| Trip | 3.7 | Unlocking from inside | 1.9, 1.10 | Road speed limit | 3.23 |
| Turn-by-turn | 3.23 | Unlocking from outside | 1.5, 1.6 | silent lock | 3.23 |
| Turning circle | 6.13 | Upper speed limit | 2.41 | tyre type | 3.25 |
| Tyre monitoring | 3.10 | setting | 2.41 | valet mode | 3.21 |
| Tyre pressures | 6.14 | USB sockets | 4.19 | wiper modes | 3.25 |
| Tyre type | 3.25 | McLaren track telemetry | 4.19 | wiper sensitivity | 3.25 |
| Tyres | 5.33 | media | 4.19 | Vehicle speeds | 6.7 |
| asymmetric | 5.33 | V | | Vehicle starting | 2.10 |
| inspecting | 5.34 | | | discharged key fob battery | 5.27 |
| | | Valet mode | 3.21 | | |

Index

| | |
|------------------------|------|
| Vehicle use | 2.42 |
| Vehicle washing | 5.38 |
| Vehicle weights | 6.9 |
| Vents | 4.9 |
| Volumetric alarm | 1.30 |

W

| | |
|--|------|
| Warning - engine oil level | 5.2 |
| Warning - engine oil temperature | 5.5 |
| Warning light | |
| Anti-lock Braking System | 2.29 |
| brakes | 2.9 |
| engine | 2.13 |
| seat belt | 1.43 |
| Supplementary Restraint System | 1.46 |
| Warning lights | 2.4 |
| Warning triangle | 5.11 |
| Washers | 5.10 |
| windscreen | 5.10 |
| Washing | 5.38 |
| exterior | 5.38 |
| wheels | 5.39 |
| Water temperature display | 3.36 |
| Wearing seat belts | 1.42 |
| Weights | 6.9 |
| Wheel - steering | 1.38 |
| electrical adjustment | 1.38 |
| manual adjustment | 1.38 |

| | |
|--|------|
| Wheel and tyre sizes | 6.13 |
| Wheel sizes | 6.13 |
| Wheels | 5.32 |
| inspecting | 5.34 |
| interchanging | 5.36 |
| Wheels and tyres | 5.32 |
| Window demisting - climate control | 4.6 |
| Windows | 4.2 |
| anti-trap protection | 4.3 |
| opening and closing | 4.2 |
| Windscreen washers | 5.10 |
| Windscreen wipers | 1.59 |
| rain sensor | 1.59 |
| single wipe | 1.59 |
| wash/wipe | 1.60 |
| wiper blade replacement | 5.30 |
| wiper modes | 3.25 |
| wiper sensitivity | 3.25 |
| Winter driving | 2.47 |
| Winter tyres | 6.13 |
| Wiper blade replacement | 5.30 |
| Wiper modes | 3.25 |
| Wiper sensitivity | 3.25 |

